

It is of vital importance, before attempting to operate your engine, to read the 'SAFETY INSTRUCTIONS AND WARNINGS' section below and to strictly adhere to the advice contained therein. Also, please study the entire contents of this instruction sheet, so as to familiarize yourself with the controls and other features of the engine.

Keep these instructions in a safe place so that you may readily refer to them whenever necessary. It is suggested that any instructions supplied with the vehicle, radio-control equipment, etc., are accessible for checking at the same time.

CONTENTS

SPECIFICATIONS, SAFETY INSTRUCTIONS AND WARNINGS ABOUT YOUR O.S. ENGINE	1
INSTALLATION, CARBURETTOR, AIR CLEANER, etc.	2
RUNNING-IN, CARBURETTOR ADJUSTMENT, etc.	3
CARE AND MAINTENANCE	4
PARTS LISTS	4



SPECIFICATIONS

Displacement	2.49cc (0.152cu.in.)	Practical R.P.M.	3,000-33,000 r.p.m.
Bore	15.0mm (0.591in.)	Power Output	1.2PS/28,000 r.p.m.
Stroke	14.1mm (0.555in.)	Weight	240g (8.47oz.)

SAFETY INSTRUCTIONS AND WARNINGS ABOUT YOUR O.S. ENGINE

Remember that your engine is not a "toy", but a highly efficient internal-combustion machine whose power is capable of harming you, or others, if it is misused or abused.

As owner, you, alone, are responsible for the safe operation of your engine, so act with discretion and care at all times.



If at some future date your O.S. engine is acquired by another person, we would respectfully request that these instructions are also passed on to its new owner.

■ The advice which follows is grouped under two headings according to the degree of damage or danger which might arise through misuse or neglect.

 **WARNINGS** Cover events which might involve serious (in extreme circumstances, even fatal) injury.

 **NOTES** Cover the many other possibilities, generally less obvious sources of danger, but which, under certain circumstances, may also cause damage or injury.

WARNINGS

- Model engine fuel is poisonous. Do not allow it to come into contact with the eyes or mouth. Always store it in a clearly marked container and out of the reach of children. 
- Model engine fuel is also highly flammable. Keep it away from naked flame, excessive heat, sources of sparks, or anything else which might ignite it. Do not smoke or allow anyone else to smoke, near to it. 
- Never operate your engine in an enclosed space. Model engines, like automobile engines, exhaust deadly carbon-monoxide. Run your engine only in an open area.
- Model engines generate considerable heat. Do not touch any part of your engine until it has cooled. Contact with the muffler (silencer), cylinder head or exhaust header pipe, in particular, may result in a serious burn. 

NOTES

- These engines were designed for model cars. Do not attempt to use them for any other purpose.
- Mount the engine in your model securely, following the manufacturers' recommendations, using appropriate screws and locknuts.
- Fit an effective silencer (muffler). Frequent close exposure to a noisy exhaust (especially in the case of the most powerful high-speed engines) may eventually impair your hearing and such noise is also likely to cause annoyance to others over a wide area.
- The wearing of safety glasses is also strongly recommended.
- Take care that the glowplug clip or battery leads do not come into contact with rotating parts. Also check that the linkage to the throttle arm is secure.
- For their safety, keep all onlookers (especially small children) well back (at least 20 feet or 6 metres) when preparing your model for running.
- To stop the engine, fully retard the throttle stick and trim lever on the transmitter, or, in an emergency, cut off the fuel supply by pinching the fuel delivery tube from the tank.
- Warning! Immediately after a glowplug-ignition engine has been run and is still warm, conditions sometimes exist whereby it is just possible for the engine to abruptly restart if it is rotated over compression WITHOUT the glowplug battery being reconnected.

The MAX-15RX has been specially designed for 2.5cc 1/10 scale track racing car competition. It makes full use of O.S. racing engine technology, resulting in one of the most powerful and durable 2.5cc class engines currently available.

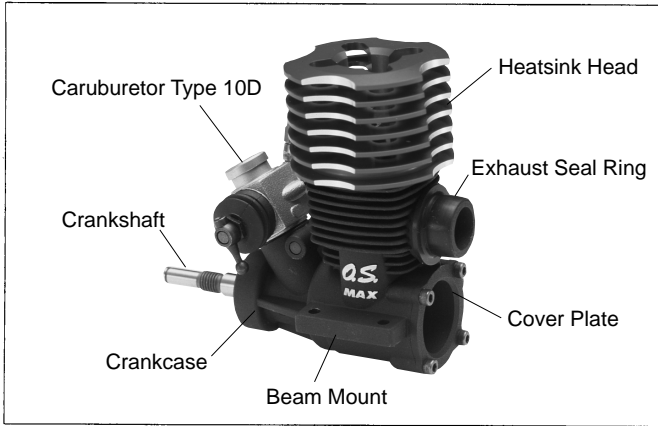

INSTALLATION

Make sure that the engine-bed mounting beams in the model are parallel, with their top surfaces in the same plane. (See below) Poor installation may not only cause erratic running and loss of power, but may also damage the engine itself by distorting the crankcase, bearings, etc. The recommended screws for securing the engine to the engine-bed mounting beams are 3mm or 4-40 steel Allen type. If the holes in the mounting beams do not align perfectly with the engine mounting lugs, enlarge them slightly with a needle file so that the fixing screws enter vertically. Avoid forcing the screws. Secure with locknuts.

INSTALLATION OF THE CARBURETOR

As delivered, the engine has its carburettor lightly fitted into its intake boss. Secure it as follows. Loosen the nut of the retainer and rotate the carburettor to its correct position. Make sure that the carburettor is pressed well down into the intake boss, compressing the rubber gasket, before retightening the nut. Rotate the nut gently until it stops, then tighten it a further 60-90°. Do not over tighten as this may damage the insulator. See below.

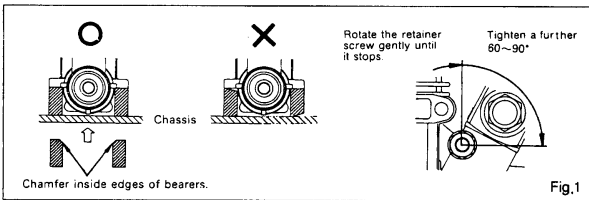

AIR CLEANER TYPE 103

This is a heavy-duty wet type air cleaner that has been developed specifically for the latest O.S. 15RX model car engine. It contains a specially impregnated filler element which prevents highly damaging dust and dirt from being drawn into the engine through the carburettor, yet allows engine performance to be maintained for longer periods between element renewals. The Type 103 air cleaner has a special rubber body which facilitates easy but secure fitting, with positive sealing at the carburettor air intake. Its one-piece shock-absorbent body guarantees a highly serviceable unit that also reduces the risk of damage to the engine itself if the car overturns or is involved in a collision.

INSTALLATION OF AIR CLEANER

- ◆ Carefully clean the carburettor, removing any old adhesive or sealant that may have been previously used on the outside of the air intake.
- ◆ Press the air cleaner body firmly over the carburettor air intake. Make sure that the outer rim of the air intake engages the internal annular groove in the air cleaner: failure to do so may result in the air cleaner falling off. (See sketch, right)

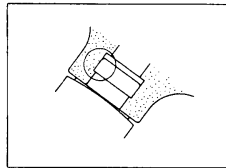

FILTER ELEMENTS

- ◆ The element is already impregnated with a special filter oil. As this oil is very sticky, take care, when handling it, to prevent dust or dirt from adhering to the elements. If your fingers become contaminated, wash them with soap and water.
- ◆ During storage, the oil may have become unevenly dispersed through the element. This will be indicated if the blue colour of the element material appears patchy. In this case, place the element in a small plastic bag and gently rub it between finger and thumb to redistribute the oil.

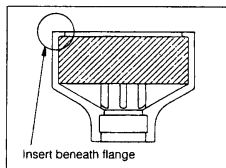

REPLACEMENT OF ELEMENTS

It is advisable to replace the filter element with a new one after not more than one hour of running time. Always remove contaminated elements carefully, to ensure that dirt cannot enter the carburettor.

TOOLS, ACCESSORIES, etc.

The following items are necessary for operating the engine.

GLOW PLUG

An O.S. R5 glowplug is fitted to the engine. When replacing the glowplug, it is advisable to use this type. The engine may not always run properly with other types of glowplug.

FUEL

Use only top quality model two-stroke engine fuel. For consistent performance and long engine life, it is advisable to use good quality fuel containing AT LEAST 18% lubricant. This engine is designed to run on both low and high nitromethane content fuels, i.e. from mild mixtures containing a few percent of nitromethane, up to high-speed racing fuels containing 40%, or more, of nitromethane. Generally, power output is increased - up to a certain point - as the nitromethane content of the fuel is increased. As a starting point, we recommend a fuel containing 10-20% nitromethane, changing to a fuel containing more nitro if necessary. When the nitro content of the fuel is increased or the brand of fuel is changed, it is advisable to initially run the engine with a richer needle-valve setting, so that the optimum setting for the new fuel may be rechecked as described in the RUNNING-IN paragraphs. When engines are run at very high speeds and on high-nitro fuels, glowplug elements do not last so long.

REMINDER!

Model engine fuel is poisonous. Do not allow it to come into contact with the eyes or mouth. Always store it in a clearly marked container and out of the reach of children.

Model engine fuel is also highly flammable. Keep it away from naked flame, excessive heat, sources of sparks, or anything else which might ignite it. Do not smoke or allow anyone else to smoke, near to it.

GLOWPLUG BATTERY

The power source for heating the glowplug may be either a large, heavy-duty 1.5-volt dry cell, or a 2-volt rechargeable lead-acid cell with extended leads (or a resistance) to reduce the applied voltage to approximately 1.5-v.

BATTERY LEADS

These are used to conduct current from the battery to the glowplug. For convenience, special leads with a suitable clip to fit the glowplug terminal, are commercially available.

LONG SOCKET WRENCH

Recommended for easy removal and replacement of the deeply recessed glowplug, the O.S. Long Socket Wrench incorporates a special grip. (See Parts List)

SILICONE TUBING

This is required for the piping between the fuel tank and engine.

ELECTRIC STARTER AND STARTER BATTERY

Use an electric starter with 12-volt battery for starting the MAX-15RX.

BEFORE STARTING THE ENGINE

- ◆ The somewhat violent changes of vehicle attitude that can occur in model car racing, combined with the fact that, in some vehicles the fuel tank may be located some way from the carburettor, means that fuel 'head' at the carburettor can vary considerably. Therefore, it is recommended that a muffler pressurized fuel feed system be used.
- ◆ Do not run your model without fitting the air cleaner to the carburettor air intake. Dust and dirt that may otherwise be drawn into the engine will rapidly shorten its life.

Note:

With this engine, the piston will feel tight at the top of its stroke when the engine is cold. This is normal. The piston and cylinder are designed to achieve a perfect running clearance when they reach their normal running temperatures.

- ◆ Use the same fuel as is to be used for all initial running (i.e. containing 10% nitromethane.)
- ◆ Open the Needle-Valve 2 1/2 turns from the fully closed position. See sketch, right.
- ◆ Set the throttle at the starting position (0.3-0.5mm Open). See sketch below.

Attention!

It is vitally important to set the throttle at the correct position before starting the engine. If the engine is allowed to run with the throttle too far open under "no load" conditions (i.e. with the driving wheels not in contact with the ground) it will rapidly overheat and may be seriously damaged.

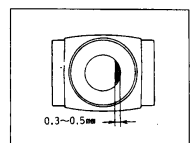
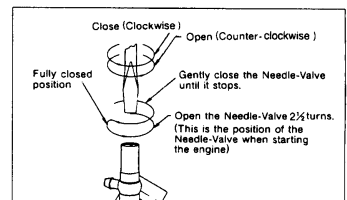

RUNNING-IN('Breaking-in')

For long life and high-performance, every engine needs to be properly 'run-in' or 'broken-in'. There are several running-in methods, but the following is suitable for use with this engine.

- ◆ Re-check the needle-valve and throttle settings. Turn the needle-valve clockwise slowly and gently until it stops. This is the fully closed position. Do not use force to turn the needle-valve beyond this point. Now reopen the needle-valve 2 1/2 turns. Set the throttle at the starting position and start the engine.
- ◆ Leaving the needle-valve at the starting setting of 2 1/2 turns open, run the car on the track with the throttle open. If the engine stops, due to being over-rich, close the needle-valve 20° to 30° and try again. It should be remembered that, at this stage, response to the throttle control will be less than perfect, due to the rich setting(indicated by dense exhaust smoke) that is required for initial running-in.
- ◆ Run the car on the track with this needle setting until one full tank of fuel has been consumed. Now close the needle-valve approximately 30° and run the vehicle for another full tank of fuel. Repeat this procedure, gradually closing the needle-valve, between runs, until the highest speed is obtained. (See diagram right). Make a note of the needle-valve setting at this point. By this time, the exhaust smoke will have thinned to a light grey colour.
- ◆ If the needle-valve is closed beyond this high-speed setting, the car will slow down, accompanied by visibly diminished exhaust smoke. In this case bring the vehicle to a halt immediately and reopen the needle-valve 20° to 30°.
- ◆ Now open the needle-valve 20° to 30° from the setting at which the highest straight-line speed can be obtained. This is the optimum needle-valve setting. Run the car for about three tanks of fuel with this optimum setting.
- ◆ The completion of the above procedure marks the conclusion of the running-in period, although, as further running time is recorded, a slight readjustment towards a leaner setting may be required to maintain maximum performance. If the engine should need to be disassembled (e.g. for cleaning or minor parts replacement) it is advisable to return the needle-valve to the original rich, starting setting and check whether further running-in time is required before the car is raced again. In the event of any major working parts (e.g. piston/cylinder liner assembly) being replaced, the complete running-in process should be repeated.

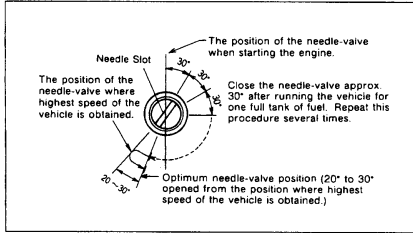

Note:

Having established the optimum needle-valve setting, make a note of the number of turns necessary to re-establish this from the closed position.

ADJUSTING THE CARBURETOR

Three adjustable controls are provided on this carburettor.(See photo below.)

• The Needle-Valve:

For adjusting the mixture strength when the throttle is fully open.

• The Mixture Control Screw:

For adjusting the mixture strength at part-throttle and idling speeds, to obtain steady idling and smooth acceleration to mid speeds.

• The Throttle Stop Screw:

For setting the position where the slide valve stops.

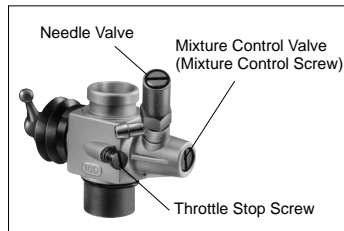

- ◆ After the optimum needle-valve setting has been determined, the mixture control screw should be checked as follows:
Close the throttle and allow the engine to idle for about five seconds, then open the throttle fully. If, at this point, the engine puffs out a good deal of smoke and does not accelerate smoothly and rapidly, it is probable that the idling mixture is too rich. In this case, turn the mixture control screw clockwise 45° to 90°. If, on the other hand, the engine tends to speed up momentarily and then cut out abruptly when the throttle is opened, the idling mixture is too lean. In this case, turn the mixture control screw counter-clockwise 45° to 90°.

Note:

Mixture control screw adjustment should be made in increments of 45° to 90°, checking the effect on the throttle response of each small adjustment.

- ◆ Carry out adjustments patiently under actual running conditions, until the engine responds quickly and positively to the throttle control.

Note:Reminder!

Mixture adjustment cannot be made accurately under 'no load' conditions (i.e. with the car off the track) which, in any case, are not advised since such running carries a risk of damaging the engine through over-revving.

- ◆ With the optimum mixture control screw position, light smoke is visible during high speed running, and the engine revolutions increase smoothly during acceleration.
Remember that, if the engine is operated with the fuel/air mixture slightly too lean, it will overheat and run unevenly. As with all engines, it is advisable to set both needle-valve and mixture control screw very slightly on the rich side of the best rpm setting, as a safety measure.
- ◆ If the engine runs too fast with the throttle closed, the throttle stop screw should be turned counter-clockwise to allow the throttle opening to be reduced.

REALIGNMENT OF MIXTURE CONTROL VALVE

In the course of making carburettor adjustments, it is just possible that the Mixture Control Valve may be inadvertently screwed in or out too far and thereby moved beyond its effective adjustment range. Its basic position can be found by first rotating the Mixture Control Valve until its slotted head is flush with the carburettor body. The valve is then screwed in exactly 2 turns to re-establish its neutral position. (See sketch below.)

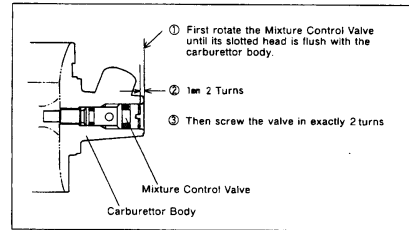

SLIDE-VALVE EXTENSION AND BALL-LINK

It is seldom necessary to separate the slide-valve extension from the slide-valve itself. For cleaning, withdraw this complete sub-assembly from the carburettor body after removing the throttle stop screw. Then wash with methanol or glow-fuel. (Note: take care not to lose the throttle stop screw; it is a special one.)

If, for any reason, it becomes essential to unscrew the slide-valve extension from the slide-valve, do not attempt this with the latter still retained in the carburettor body; to do so may cause the throttle stop screw to burr the slide-valve, which will then fail to operate smoothly within the carburettor body. When it is necessary to adjust the ball-link position, loosen the ball-link retaining screw with a 1.5mm hexagon key, re-align the ball-link and re-tighten the screw firmly.

CARBURETOR CLEANLINESS

The correct functioning of the carburettor depends on its small fuel orifices remaining clear. The minute particles of foreign matter that are present in any fuel, can easily partially obstruct these orifices and upset mixture strength so that engine performance becomes erratic and unreliable. O.S. 'Super-Filters' (large and small) are available, as optional extras, to deal with this problem. One of these filters, fitted to the outlet tube inside your refueling container, will prevent the entry of foreign material into the fuel tank. It is also recommended that a good in-line filter be installed between the tank and carburettor.

Do not forget to clean the filters regularly to remove dirt and lint that accumulate on the filter screens. Also clean the carburettor itself occasionally.

CARE AND MAINTENANCE

- ◆ At the end of each operating session, drain the fuel tank. Afterwards, energize the glowplug and try to restart the engine, to burn off any fuel that may remain inside the engine. Repeat this procedure until the engine fails to fire. Try to eject residue while the engine is still warm.

- ◆ Finally, inject some corrosion inhibiting oil, and rotate the engine to distribute the oil to all the working parts. Do not, however, inject this oil into the carburettor as it may cause the O-rings inside to deteriorate.

Note:

These maintenance procedures will reduce the risks of starting difficulties or corrosion after a period of storage.

- ◆ When cleaning the exterior of the engine, use methanol or kerosene. Do not use gasoline or any solvent that might damage the silicone fuel tubing.

Caution:

The rear crankshaft bearing of this engine uses a special plastic retainer. If the front housing needs to be heated to remove or replace the bearing, do not allow the bearing to exceed 120°C(248°F), otherwise it may be damaged and rendered unserviceable.

PARTS LIST

No.	Code No.	Description
1	2 3818 500	Throttle Stop Screw(w/spring)
2	2 1285 600	Mixture Control Valve Assembly
2-1	4 6066 319	"O" Ring(L)for Mixture Control Valve
2-2	2 2781 800	"O" Ring(S)for Mixture Control Valve
3	2 1285 901	Needle Valve Assembly
3-1	2 7881 820	"O" Ring for needle
4	2 1881 101	Carburettor Body
5	2 2615 000	Carburettor Gasket
6	2 1881 200	Slide Valve
7	2 1881 300	Metering Needle Assembly
8	2 1285 210	Slide Valve Extension
9	2 1881 320	Dust Cover
10	2 3818 410	Ball Link No.2

The specifications are subject to alteration for improvement without notice.

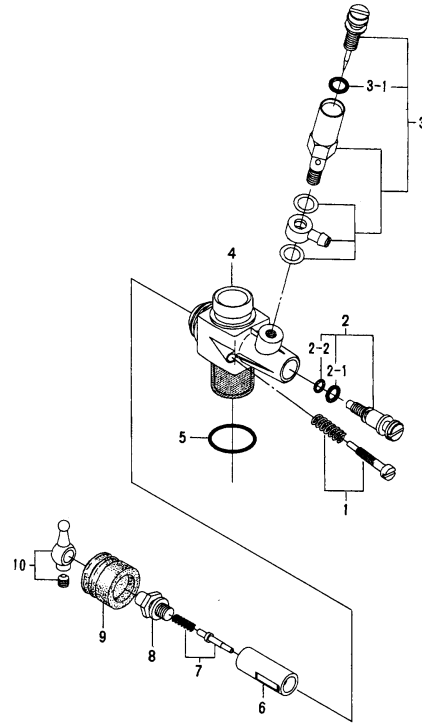

PARTS LIST

No.	Code No.	Description
①	2 1801 000	Crankcase
②	2 1802 000	Crankshaft
③	2 1803 010	Cylinder & Piston Assembly
④	2 1804 200	Heatsink Head
⑤	2 1805 000	Connecting Rod
⑥	2 1806 000	Piston Pin
⑦	2 3817 000	Piston Pin Retainer
⑧	2 1807 000	Cover Plate
⑨	2 1813 000	Screw Set
⑩	2 1814 000	Gasket Set
⑪	4 1614 000	Crankshaft Ball Bearing (F)
⑫	2 3430 000	Crankshaft Ball Bearing (R)
⑬	2 1881 001	Carburettor Complete 10D
⑭	2 5381 701	Carburettor Retainer Assembly
⑮	2 1826 100	Exhaust Seal Ring
	7 1605 200	Glow Plug R5
	7 2403 300	Super Air Cleaner 103
	*7 2103 010	Tuned Silencer T-1010
	*7 2103 210	Exhaust Header Pipe
	*7 2103 220	Exhaust Header Pipe Spring
	*7 2103 310	Super Joint Tube 15
	*7 2403 320	103 Filter Elements
	*7 1530 200	Crankshaft Clamp 1521
	*7 1511 006	O.S. Mini Tool Set
	*7 1521 000	Long Socket Wrench

Note:As a spare, 72403320 contains four filter elements, while a complete air cleaner is supplied with two filter elements.

* Optional extra parts

The specifications are subject to alteration for improvement without notice.

