

PARTS

A PARTS ×1
0449053

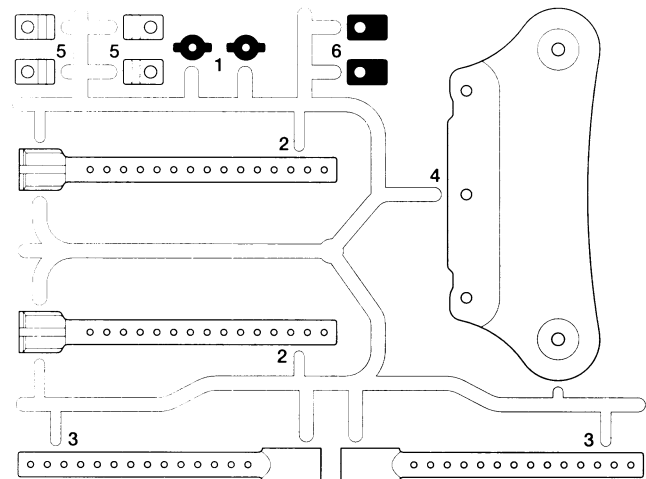

C PARTS ×1
50867

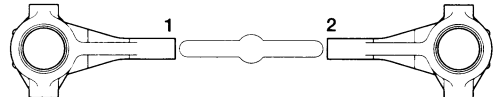

F PARTS ×1
0004155

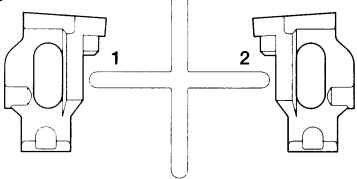

E PARTS ×1
53472

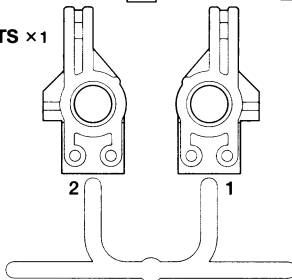

D PARTS ×2
9004131

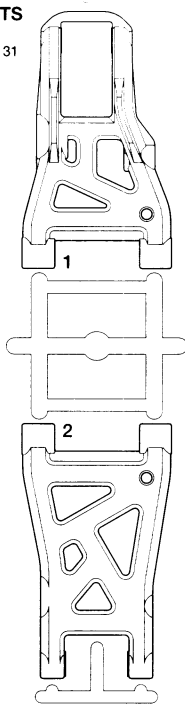

M PARTS ×1
50874

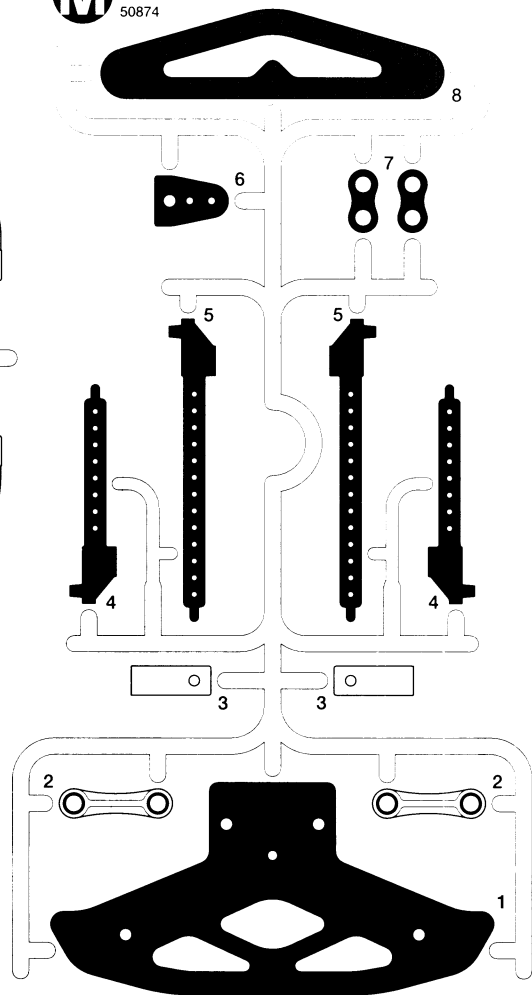

不要部品
Not used.
Nicht verwenden.
Non utilisées.

カーボン部品袋詰
Carbon parts bag
Karbonteile-Beutel
Sachet de pièces en fibres de carbone.

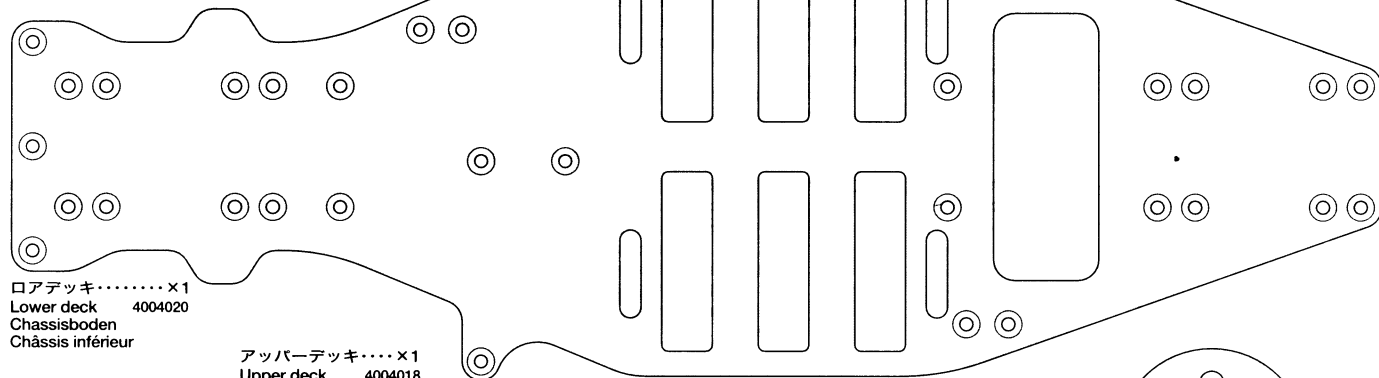

ロアデッキ.....×1
Lower deck 4004020
Chassisboden
Châssis inférieur

アッパーデッキ.....×1
Upper deck 4004018
Oberes Deck
Platine supérieure

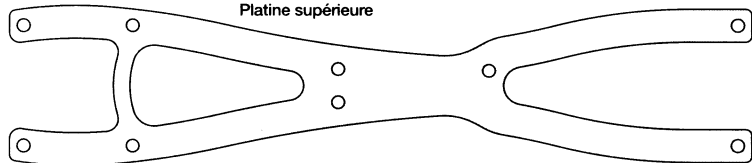

MD1 ×1 リンケージプレート
4034010 Linkage plate
Verbindungsplatte
Plaque de liaison

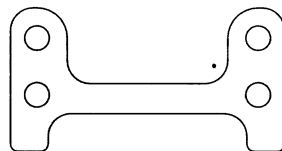

MD2 ×1 スタビホルダーA
4034013 Stabilizer holder A
Stabilisator-Halter A
Support de barre anti-roulis A

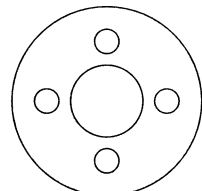

MD3 ×1 スパーホルダー
4304023 Spur holder
Spornhalterung
Support de couronne

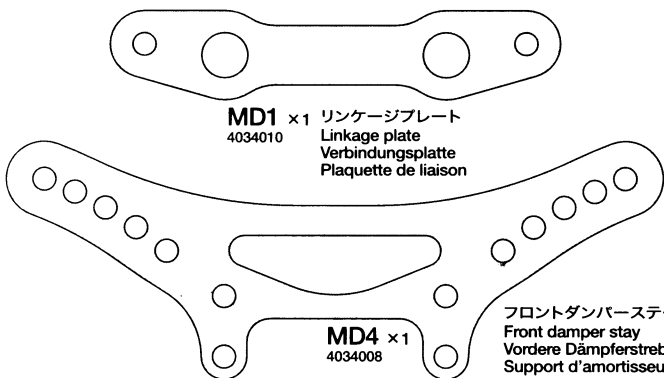

MD4 ×1
4034008

フロントダンパーステー
Front damper stay
Vordere Dämpferstrebe
Support d'amortisseur avant

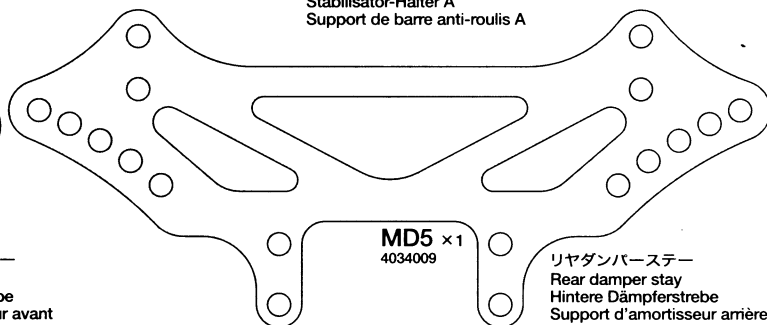

MD5 ×1
4034009

リヤダンパーステー
Rear damper stay
Hintere Dämpferstrebe
Support d'amortisseur arrière

PARTS

★製品改良のためキットは予告なく仕様を変更することがあります。
 ★Specifications are subject to change without notice.
 ★Technische Daten können im Zuge ohne Ankündigung verändert werden.
 ★Caractéristiques pouvant être modifiées sans information préalable.

- | | |
|--|--|
| ベルト(長).....×1
Drive belt (long) 6244005
Antriebsriemen (lang)
Courroie (long) | アンテナパイプ.....×1
Antenna pipe 6095003
Antennendraht
Gaine d'antenne |
| ベルト(短).....×1
Drive belt (short) 6244004
Antriebsriemen (kurz)
Courroie (court) | ウレタンバンパー.....×1
Urethane bumper 6275052
Urethan-Stoßfänger
Pare-chocs en mousse |

Q PARTS ×1
50473

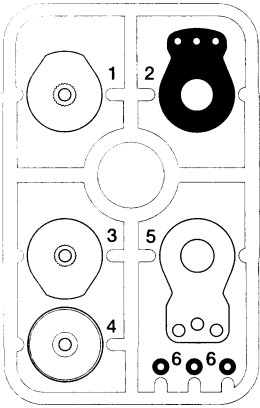

V PARTS ×4
53334

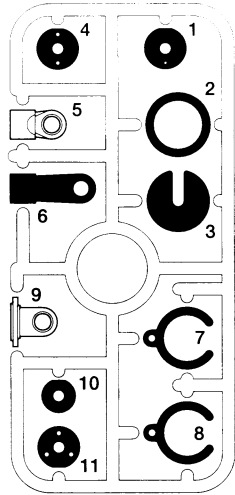

不要部品
Not used.
Nicht verwenden.
Non utilisées.

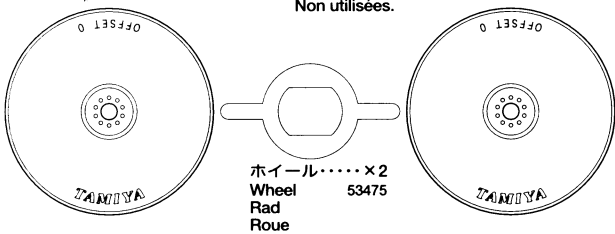

ホイール.....×2
Wheel 53475
Rad
Roue

- ボディ.....×1
Body
Karosserie
Carrosserie
- ステッカー.....×4
Sticker

スパーギヤ袋詰
Spur gear bag
Stirnradgetriebe-Beutel
Sachet de pignons intermédiaire

- スパーギヤ.....×3
Spur gear 9334079
Stirnradgetriebe
Pignons intermédiaire

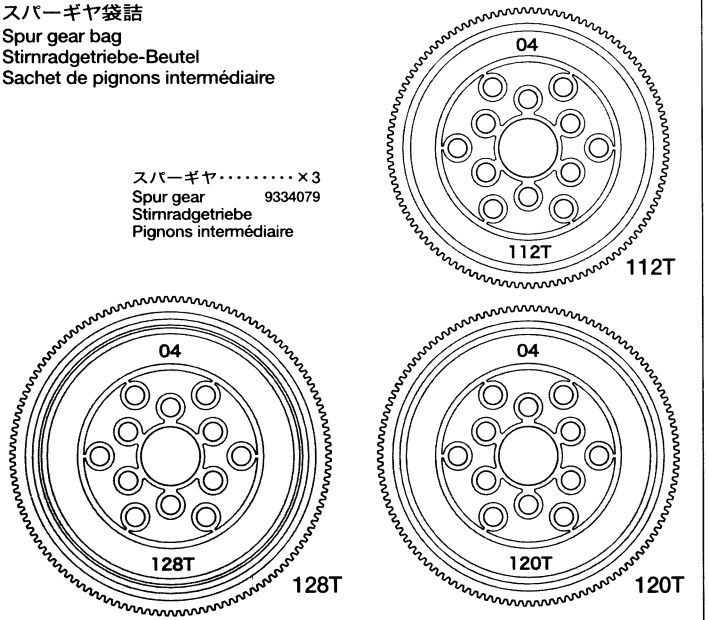

バルクヘッド袋詰
Bulkhead bag
Lagerschild-Beutel
Sachet de cloison

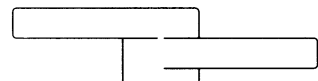

ME1 ×1
9805770
ステアリングアーム(L)
Steering arm (left)
Schubstangen (links)
Commande de direction (gauche)

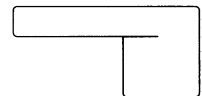

ME2 ×1
9805770
ステアリングアーム(R)
Steering arm (right)
Schubstangen (rechts)
Commande de direction (droite)

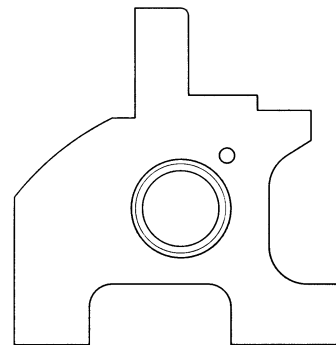

ME6 ×1
3454160
フロントバルクヘッド(L)
Front bulkhead (left)
Vorderer Lagerschild (links)
Cloison avant (gauche)

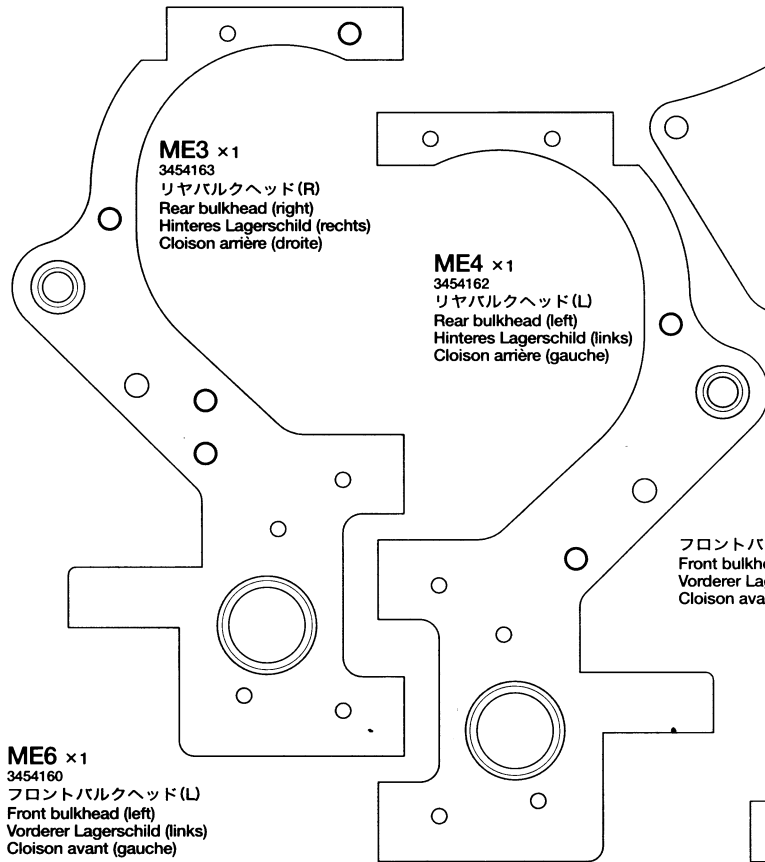

ME3 ×1
3454163
リヤバルクヘッド(R)
Rear bulkhead (right)
Hinteres Lagerschild (rechts)
Cloison arrière (droite)

ME4 ×1
3454162
リヤバルクヘッド(L)
Rear bulkhead (left)
Hinteres Lagerschild (links)
Cloison arrière (gauche)

ME5 ×1
3454164
モータープレート
Motor plate
Motor-Platte
Plaque-moteur

ME7 ×1
3454161
フロントバルクヘッド(R)
Front bulkhead (right)
Vorderer Lagerschild (rechts)
Cloison avant (droite)

サスブロック袋詰
Suspension block bag
Aufhängungsklotz-Beutel
Sachet des bloc de suspension

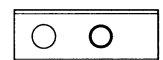

MK1 ×2
9804150
スタビホルダーB
Stabilizer holder B
Stabilisator-Halter B
Support de barre anti-roulis B

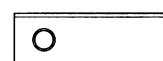

MK2 ×2
9805796
サーボステー
Servo stay
Servohalterung
Support de servo



MK3 ×4
9804151
ダンパーリテーナー
Damper retainer
Dämpferkeil
Maintien d'amortisseur

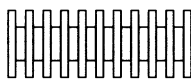

MK4 ×1
3454071
バルクヘッドビーム
Bulkhead beam
Querträger
Tige de cloison

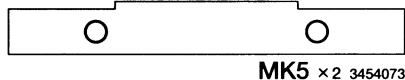

MK5 ×2 3454073

サスアームブロックA(0°)
Suspension arm block A
Klotz A des Aufhängungsarms
Bloc de bras de suspension A

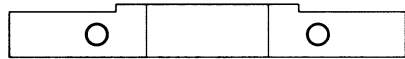

MK6 ×1 3454156

サスアームブロックB
Suspension arm block B
Klotz B des Aufhängungsarms
Bloc de bras de suspension B

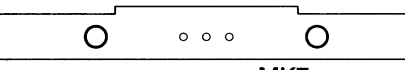







MK7 ×1 3454077

サスアームブロックE(+1.5°)
Suspension arm block E
Klotz E des Aufhängungsarms
Bloc de bras de suspension E

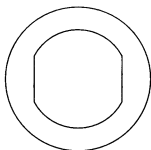
PARTS

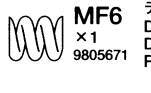

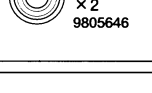

ベアリング袋詰

Ball bearing bag
Kugellager-Beutel
Sachet de roulements à billes

	MF1 ×1 53008	1150ベアリング Ball bearing Kugellager Roulement à billes		MF5 ×2 50880 デフプレート Diff plate Differentialplatte Plaque de diff
	MF2 ×2 53030	850ベアリング Ball bearing Kugellager Roulement à billes		MF6 ×1 9805671 デフスプリング Diff spring Differentialfeder Ressort de diff
	MF3 ×2 9805672	840ベアリング Ball bearing Kugellager Roulement à billes		MF7 ×1 9805670 620スラストベアリング Ball thrust bearing Druckkugellager Butée à billes
	MF4 ×4 5700066	850フランジベアリング Flanged ball bearing Flansch-Kugellager Roulement à flasque		MF8 ×2 9805646 630フランジベアリング Flanged ball bearing Flansch-Kugellager Roulement à flasque

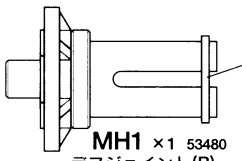

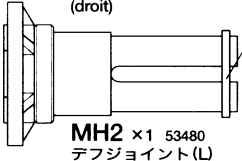
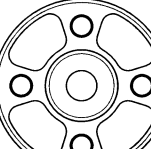
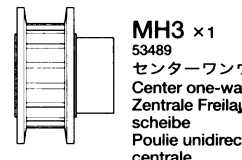
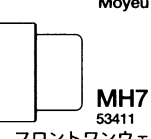

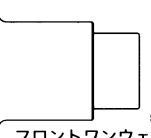
デフジョイント袋詰

Diff joint bag
Differential-Gelenk Beutel
Sachet d'accouplements de différentiel

	MH1 ×1 53480 デフジョイント(R) Diff joint (right) Differential-Gelenk (rechts) Accouplement de différentiel (droit)		MH5 ×2 53480 デフハウジングスペーサー Diff housing spacer Distanzstück Diff-Gehäuse Entretoises de carter de diff ★MH1、MH2から取り外します。 ★Remove from MH1 and MH2. ★An MH1 und MH2 entfernen. ★Enlever de MH1 et MH2.
	MH2 ×1 53480 デフジョイント(L) Diff joint (left) Differential-Gelenk (links) Accouplement de différentiel (gauche)		MH6 ×1 3459064 スパーギヤハブ Spur gear hub Stirnradnabe Moyeu de pignon intermédiaire
	MH3 ×1 53489 センターワンウェイ Center one-way pulley Zentrale Freilauf-Riemenscheibe Poulie unidirectionnelle centrale		MH7 ×1 53411 フロントワンウェイハウジング(L) Front one-way housing (left) Gehäuse des Vorderer-Einweg (links) Logement de roue unidirectionnel (gauche)
	MH4 ×1 53474 センタープーリー Center pulley Zentrale Riemenscheibe Poulie centrale		MH8 ×1 53411 フロントワンウェイハウジング(R) Front one-way housing (right) Gehäuse des Vorderer-Einweg (rechts) Logement de roue unidirectionnel (droite)

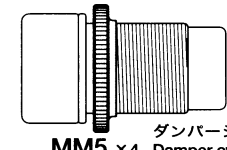

ダンパー部品袋詰

Damper parts bag
Stoßdämpfer Teile-Beutel
Sachet de pièces d'amortisseur

	MM1 ×4 9805731 ウレタンブッシュ Urethane bushing Urethan-Buchse Bague polyuréthane		MM5 ×4 9805860 ダンパーシリンダー Damper cylinder Dämpfer-Zylinder Corps d'amortisseur
	MM2 ×4 9949131 3mm Oリング(シリコン) Silicone O-ring Silikon-O-Ring Joint silicone		MM6 ×4 53440 コイルスプリング Coil spring Spiralfeder Ressort hélicoïdal
	MM3 ×2 9805240 3mm Oリング(黒) O-ring (black) O-Ring (schwarz) Joint torique (noir)		
	MM4 ×4 9805491 オイルシール Oil seal Ölabdichtung Joint d'étanchéité		

ボールデフ部品袋詰

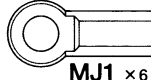
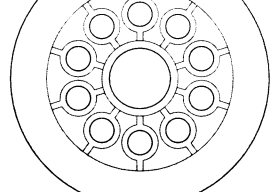
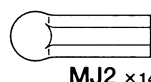
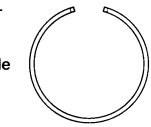
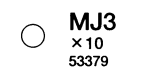
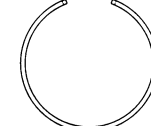
Ball differential bag
Kugeldifferential Beutel
Sachet de différentiels à billes

	6mmアジャスター Adjuster Einstellstück Chape à rotule MJ1 ×6 0445749		MJ4 ×2 50877 32Tボールデフプーリー 32T Ball differential pulley 32Z Kugeldifferential-Antriebsrad Poulie de diff. à billes 32 dents
	5mmアジャスター Adjuster Einstellstück Chape à rotule MJ2 ×14 50875		MJ5 ×2 50473 サーボセイバースプリング(金) Servo saver spring (gold) Servo-Saver-Feder (gold) Ressort de sauve-servo (doré)
	3mm軽量ボール Ball Kugel Bille MJ3 ×10 53379		MJ6 ×1 50473 サーボセイバースプリング(銀) Servo saver spring (silver) Servo-Saver-Feder (silver) Ressort de sauve-servo (chromé)
	アンチウェアグリス……×1 Anti-wear grease 53439 Verschleiß mindermendes Fett Graisse anti-usure		ボールデフグリス……×1 Ball Diff Grease 53042 Fett für Kugeldifferential Graisse pour différentiel à billes



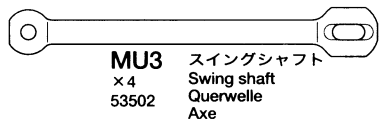
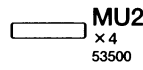
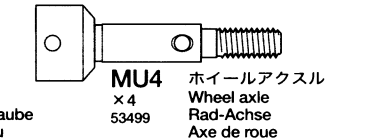
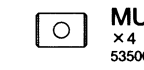

ユニバーサルシャフト袋詰

Universal shaft bag
Gelenkwelle Beutel
Sachet de cardans articulé

	MU1 ×4 53500 3×2.5mmイモネジ Grub screw Madenschraube Vis pointeau		MU3 ×4 53502 スイングシャフト Swing shaft Querwelle Axe
	MU2 ×4 53500 2×9.8mmシャフト Shaft Achse Axe		MU4 ×4 53499 ホイールアクスル Wheel axle Rad-Achse Axe de roue
			MU5 ×4 53500 クロススパイダー Cross joint Kreuzzapfen Joint croisé

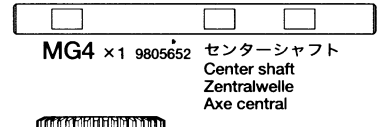

ピニオン袋詰

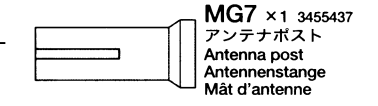
Pinion gear bag
Motormitzel-Beutel
Sachet du pignon moteur

	MG1 ×1 50877 ロックナットホルダー Lock nut holder Sicherungsmuttern-Halter Maintien d'écrou à flasques		MG4 ×1 9805652 センターシャフト Center shaft Zentralwelle Axe central
	MG2 ×12 9804152 5.5×3mmスペーサー Spacer Distanzring Entretoise		MG5 ×1 3514009 40Tピニオンギヤ 40T Pinion gear 40Z Motormitzel Pignon moteur 40 dents
	MG3 ×24 9804153 5.5×2mmスペーサー Spacer Distanzring Entretoise		MG6 ×2 53451 ワンウェイジョイント One-way joint Freilaufgelenk Joint à sens unique
			MG7 ×1 3455437 アンテナポスト Antenna post Antennenstange Mât d'antenne

ピストン袋詰

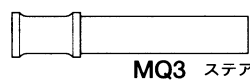
Piston bag
Kolben-Beutel
Sachet de pistons

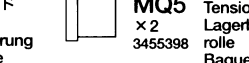
	MQ1 ×4 9805638 ピストン Piston Kolben		MQ3 ×2 9805742 ステアリングポスト Steering post Lagerzapfen der Lenkung Colonnnettes de direction
	MQ2 ×4 7795003 ロッドガイド Rod guide Stangenführung Guide d'axe		MQ4 ×4 9949131 デフロンスペーサー Damper spacer Dämpfer-Distanzring Entretoise d'amortisseur
			MQ5 ×2 3455398 テンションプーリー Tension pulley bushing Lagerbuchse für Riemenspannrolle Bague de poulie de tension

PARTS

★金具部品は少し多目に入っています。予備、セッティング用として使ってください。
 ★Extra screws and nuts are included. Use them as spares.
 ★Ersatzschrauben und -muttern liegen bei.
 ★Des vis et des ecrous supplémentaires inclus. Les utiliser comme pieces de rechange.

ホイールハブ袋詰

Wheel hub bag
 Radnabe-Beutel
 Sachet de moyeux de roue

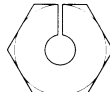

MN2 ×4 9404353
 ホイールハブ
 Wheel hub
 Radnabe
 Moyeu de roue

MN1 ×4 9404353
 1.6×4mmキャップスクリュー
 Cap screw
 Zylinderkopfschraube
 Vis à tête cylindrique

MN3 ×4 50594
 2×10mmシャフト
 Shaft
 Achse
 Axe

スペーサー袋詰

Spacer bag
 Distanzring-Beutel
 Sachet d'entretoises



MR4 ×10 9805648
 5×2mmスペーサー
 Spacer
 Distanzring
 Entretoise

MR1 ×11 9805645
 3×0.7mmスペーサー
 Spacer
 Distanzring
 Entretoise

MR5 ×2 9805653
 フランジパイプS
 Flanged tube (short)
 Kragenrohr (kurz)
 Tube à flasque (court)

MR2 ×12 9805651
 7×3mmスペーサー
 Spacer
 Distanzring
 Entretoise

MR6 ×6 9805705
 3mm皿ワッシャー
 Washer
 Beilagscheibe
 Rondelle

MR3 ×12 9805762
 7×2mmスペーサー
 Spacer
 Distanzring
 Entretoise

MR7 ×4 9805693
 6mmワッシャー
 Washer
 Beilagscheibe
 Rondelle

シャフト袋詰

Shaft bag
 Achse-Beutel
 Sachet d'axes

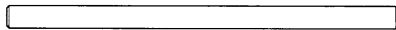

MS4 ×4 9805741
 3×51.3mmシャフト
 Shaft
 Achse
 Axe

MS1 ×5 53528
 3×35mmターンバックルシャフト
 Turn-buckle shaft
 Spann-Achse
 Biellette à pas inversés

MS5 ×2 9805682
 3×30mmシャフト
 Shaft
 Achse
 Axe

MS2 ×2 53526
 3×23mmターンバックルシャフト
 Turn-buckle shaft
 Spann-Achse
 Biellette à pas inversés

MS6 ×2 9805683
 3×25.3mmシャフト
 Shaft
 Achse
 Axe

MS3 ×2 53525
 3×18mmターンバックルシャフト
 Turn-buckle shaft
 Spann-Achse
 Biellette à pas inversés

MS7 ×4 9805504
 ピストンロッド
 Piston rod
 Kolbenstange
 Axe de piston

ピロボール袋詰

Ball connector bag
 Kugelkopf-Beutel
 Sachet de connecteurs à rotule

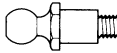

MP4 ×2 9805740
 5mmピロボールキングピン
 Ball-head king pin
 Kugelkopf-Drehzapfen
 Rotule déportée

MP1 ×8 9805739
 サスボール
 Suspension ball
 Aufhängungs-Kugel
 Rotule de suspension



MP5 ×9 53284
 5mmアルミピロボール
 Ball connector
 Kugelkopf
 Connecteur à rotule

MP2 ×4 9805768
 6×6.5mmボールナット
 Ball nut
 Kugelkopfmutter
 Ecrou à rotule



MP6 ×4 9805673
 スタビエンド
 Stabilizer end
 Stabilisator-Endstück
 Extrémités de barre stabilisatrice

MP3 ×9 9805769
 5mmピロボールナット
 Ball connector nut
 Kugelkopf-Mutter
 Ecrou-connecteur à rotule



MP7 ×2 9804154
 5mmスチールピロボール
 Ball connector
 Kugelkopf
 Connecteur à rotule

工具袋詰

Tool bag
 Werkzeug-Beutel
 Sachet d'outillage

両面テープ……………×1
 Double-sided tape 50171
 Doppelklebeband
 Adhésif double face

六角棒レンチ(2mm)……………×1
 Hex wrench (2mm) 2990027
 Imbusschlüssel (2mm)
 Clé Allen (2mm)

六角棒レンチ(1.5mm)……………×1
 Hex wrench (1.5mm) 50038
 Imbusschlüssel (1.5mm)
 Clé Allen (1.5mm)

十字レンチ……………×1
 Box wrench 50038
 Steckschlüssel
 Clé à tube

MT1 ×1 50038
 アンテナキャップ
 Antenna cap
 Antennenkappe
 Capuchon d'antenne

ウイング袋詰

Wing parts bag
 Flügeltteile-Beutel
 Sachet de pieces d'aileron



MW1 ×2 3×10mm六角皿ビス
 Screw
 Schraube
 Vis



MW2 ×2 2220001
 3mmロックナット
 Lock nut
 Sicherungsmutter
 Ecrou nylonstop



MW3 ×2 50586
 3mmワッシャー
 Washer
 Beilagscheibe
 Rondelle



MW4 ×2 9805631
 ロゼットワッシャー
 Rosette washer
 Rosetten-Beilagscheibe
 Rondelle fraisée

ウイング……………×1
 Wing
 Spoiler
 Aileron

ウイングプレート……………×2
 Wing plate
 Spoilerplatte
 Panneau d'aileron

ビス袋詰A

Screw bag A
 Schraubenbeutel A
 Sachet de vis A

MA4 ×1 9805669
 2×25mmキャップスクリュー
 Cap screw
 Zylinderkopfschraube
 Vis à tête cylindrique

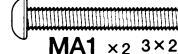

MA1 ×2 3×20mm六角丸ビス
 Screw
 Schraube
 Vis

MA5 ×4 9805831
 2×8mmキャップスクリュー
 Cap screw
 Zylinderkopfschraube
 Vis à tête cylindrique



MA2 ×13 53529
 3×8mm六角丸ビス
 Screw
 Schraube
 Vis



MA6 ×9 50586
 3mmワッシャー
 Washer
 Beilagscheibe
 Rondelle



MA3 ×1 2.6×10mmキャップスクリュー
 Cap screw
 Zylinderkopfschraube
 Vis à tête cylindrique

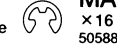

MA7 ×16 50588
 2mmEリング
 E-Ring
 Circlip

ビス袋詰B

Screw bag B
 Schraubenbeutel B
 Sachet de vis B



MB4 ×6 53538
 3×16mm六角皿ビス
 Screw
 Schraube
 Vis



MB1 ×2 9805629
 3×12mmタッピングビス
 Tapping screw
 Schneidschraube
 Vis taraudeuse



MB5 ×8 53536
 3×12mm六角皿ビス
 Screw
 Schraube
 Vis



MB2 ×1 50575
 2.6×10mmタッピングビス
 Tapping screw
 Schneidschraube
 Vis taraudeuse



MB6 ×24 53534
 3×8mm六角皿ビス
 Screw
 Schraube
 Vis



MB3 ×24 53530
 3×10mm六角丸ビス
 Screw
 Schraube
 Vis



MB7 ×6 9805684
 3×12mmホロービス
 Screw
 Schraube
 Vis

ビス袋詰C

Screw bag C
 Schraubenbeutel C
 Sachet de vis C



MC2 ×1 2mmロックナット
 Lock nut
 Sicherungsmutter
 Ecrou nylonstop



MC3 ×4 53161
 4mmフランジロックナット
 Flange lock nut
 Sicherungsmutter
 Ecrou nylonstop à flasque



MC1 ×7 50576
 3mmイモネジ
 Grub screw
 Madenschraube
 Vis pointeau



MC4 ×10 9805702
 6mmスナップピン
 Snap pin
 Federstift
 Epingle métallique

六角棒レンチ(2mm)……………×1
 Hex wrench (2mm) 2990027
 Imbusschlüssel (2mm)
 Clé Allen (2mm)

六角棒レンチ(1.5mm)……………×1
 Hex wrench (1.5mm) 50038
 Imbusschlüssel (1.5mm)
 Clé Allen (1.5mm)

十字レンチ……………×1
 Box wrench 50038
 Steckschlüssel
 Clé à tube

MT1 ×1 50038
 アンテナキャップ
 Antenna cap
 Antennenkappe
 Capuchon d'antenne

ナイロンバンド……………×3
 Nylon band 50595
 Nylonband
 Collier nylon

板レンチ……………×1
 Wrench 4305026
 Mutternschlüssel
 Clé

MT2 ×1 5304019
 フロントスタビライザー(銀)
 Front stabilizer (silver)
 Vorderer Stabilisator (silber)
 Barre anti-roulis avant (aluminium)

MT3 ×1 5304006
 リヤスタビライザー(青)
 Rear stabilizer (blue)
 Hinterer Stabilisator (blau)
 Barre anti-roulis arrière (bleu)

AFTER MARKET SERVICE CARD

When purchasing Tamiya replacement parts, please take or send this form to your local Tamiya dealer so that the parts required can be correctly identified and supplied.

KUNDENNACHBETREUUNGS-KARTE

Wenn Sie TAMIYA-Ersatzteile kaufen möchten, nehmen Sie bitte zur Unterstützung dieses Formular mit zu Ihrem örtlichen Fachhändler. Bezüglich der Angaben, der Lagerhaltung der Artikel und der Preise sind Änderungen vorbehalten.

SERVICE APRES-VENTE

Liste des pièces détachées Afin de vous permettre de vous procurer des pièces de rechange Tamiya, Amenez cette liste à votre point de vente Tamiya qui ne manquera pas de vous renseigner. Veuillez noter que les caractéristiques, disponibilité et prix peuvent changer sans avis préalable.

PARTS CODE

- 4004020 Lower Deck
4004018 Upper Deck
A Parts (A1-A6)
TA04 C Parts (Front Upright) (C1 & C2)
D Parts (D1 & D2, 2 pcs.)
TA04 Toe-in Rear Uprights (E1 & E2)
TA04 Racing Hub Carrier Set (F1 & F2...etc.)
F Parts (F1 & F2)
TA04 M Parts (Bumper) (M1-M8)
Hi-Torque Servo Saver Set (Q1-Q6, MJ5, MJ6...etc.)
Low Friction Damper V Parts (V1-V11, 2 pcs.)
Spur Gear Bag (04 Module; 112T, 120T, 128T)
Urethane Bumper
Front Drive Belt (Long)
Rear Drive Belt (Short)
Medium-Narrow White Dish Wheels (4 pcs.)
Screw Bag A (MA1-MA7)
3x8mm Titanium Hex Socket Screw (MA2 x5)
2x25mm Cap Screw (MA4 x2)
2x8mm Cap Screw (MA5 x2)
3mm Washer (MA6 x15)
2mm E-ring (MA7 x15)
Screw Bag B (MB1-MB7)
3x12mm Tapping Screw (MB1 x4)
2.6x10mm Tapping Screw (MB2 x5)
3x10mm Titanium Hex Socket Screw (MB3 x5)
3x16mm Titanium Countersunk Hex Head Screw (MB4 x5)
3x12mm Titanium Countersunk Hex Head Screw (MB5 x5)
3x8mm Titanium Countersunk Hex Head Screw (MB6 x5)
3x12mm Screw (MB7 x2)
Screw Bag C (MC1-MC4)
3mm Grub Screw (MC1 x10)
Tool Set (Box Wrench, Hex Wrench "1.5mm", MC1 x4)
4mm Anodized Aluminum Flange Lock Nuts (Gold, MC3 x5)
6mm Snap Pin (MC4 x10)
Linkage Plate (MD1)
Stabilizer Holder A (MD2)
Spur Holder (MD3)
Front Damper Stay (MD4)
Rear Damper Stay (MD5)
Steering Arm L & R (ME1 & ME2, Silver)
Rear Bulkhead R (ME3, Blue)
Rear Bulkhead L (ME4, Blue)

- Motor Plate (ME5, Blue)
Front Bulkhead L (ME6, Blue)
Front Bulkhead R (ME7, Blue)
1150 Sealed Ball Bearing (MF1 x4)
850 Sealed Ball Bearing (MF2 x4)
840 Ball Bearing (MF3 x2)
850 Flanged Ball Bearing (MF4 x1)
TA04 Diff. Plate Set (MF5 x2)
Diff. Spring (MF6 x2)
620 Ball Thrust Bearing (MF7 x2)
630 Flanged Ball Bearing (MF8 x2)
TA04 Ball Diff. Pulley (MG1 & MJ4)
5.5x3mm Spacer (MG2 x10, Blue)
5.5x2mm Spacer (MG3 x10, Blue)
Center Shaft (MG4...etc.)
40T Pinion Gear (MG5)
TA04 Front One-Way Joint Set (MG6 x2)
Antenna Post (MG7)
TA04 Lightweight Diff. Joint Set (MH1, MH2, MH5 x4)
TA04 Aluminum Center One-Way Pulley (MH3)
TA04 Aluminum Center Pulley (MH4)
Spur Gear Hub (MH6, Silver)
TA04 Front One-Way Unit (MH7, MH8, MG6...etc.)
6mm Adjuster (MJ1 x4)
5mm Adjuster (MJ2 x8)
3mm Lightweight Diff. Ball Set (MJ3 x20)
Stabilizer Holder B (MK1 x2, Blue)
Servo Stay (MK2 x2, Silver)
Damper Retainer (MK3 x4, Blue)
Bulkhead Beam (MK4, Silver)
Suspension Arm Block A (MK5 x1, Silver)
Suspension Arm Block B (MK6, Blue)
Suspension Arm Block E (MK7, Silver)
Urethane Bushing (MM1 x4)
Fluorine Resin Spacer Set (MM2 & MQ4, 4 pcs. each)
3mm O-ring (Black) (MM3 x7...etc.)
Oil Seal (MM4 x2)
Damper Cylinder (MM5 x2)
On-Road Tuned Hard Spring Set (MM6 x2...etc.)
Wheel Hub Bag (MN1-MN3, 4 pcs. each)
2x10mm Shaft (MN3 x10)
Suspension Ball (MP1 x10)
6x6.5mm Aluminum Ball Nut (MP2 x10)
5mm Aluminum Ball Connector Nut (MP3 x10, Silver)

- 5mm Ball-Head King Pin (MP4 x2)
5mm Aluminum Ball Connector (MP5 x10, Silver)
Stabilizer End (MP6 x4, Silver)
5mm Ball Connector (MP7 x2, Black)
Piston (MQ1 x2)
Fluorine Resin Piston Set (MQ2 x4...etc.)
Steering Post (MQ3 x2, Silver)
Tension Pulley Bushing (MQ5 x1)
3x0.7mm Spacer (MR1 x10)
7x3mm Spacer (MR2 x10)
7x2mm Spacer (MR3 x10)
5x2mm Spacer (MR4 x10)
Flanged Tube S (MR5 x2...etc.)
3mm Washer (MR6 x6)
6mm Washer (MR7 x5)
3x35mm Titanium Turnbuckle Shafts (MS1 x2)
3x23mm Titanium Turnbuckle Shafts (MS2 x2)
3x18mm Titanium Turnbuckle Shafts (MS3 x2)
3x51.3mm Shaft (MS4 x4)
3x30mm Shaft (MS5 x2)
3x25.3mm Shaft (MS6 x2)
Piston Rod (MS7 x2)
Front Stabilizer (MT2)
Rear Stabilizer (MT3)
Cross Joint for Assembly Universal Shaft Set (MU1, MU2, MU5)
39mm Lightweight Rear Swing Shafts for Assembly Universal Shaft Set (MU3 x2)
Wheel Axles for Assembly Universal Shaft Set (MU4 x2)
3mm Lock Nut (MW2 x1)
3mm Rosette Washer (MW4 x4)
Heat Resistant Double-Sided Tape
Nylon Band w/Metal Hook (10 pcs.)
Ball Diff. Grease
Anti-Wear Grease
2mm Hex Wrench
Wrench
Antenna Pipe (30cm) (White)
Sticker (for TRF414M WCSR Chassis Kit)
Sticker (for TRF414M WCSR Kit)
Instructions
Requires 2 sets for one car.
Requires 3 sets for one car.
Requires 4 sets for one car.

★部品請求にはこのカードが必要です。
部品請求をなさる方はあなたの氏名、住所、郵便番号、電話番号をこのカードに記入してください。



ワールドチャンピオンレプリカシャーシキット

部品をなくしたり、こわした方は、下のステッカーが貼られたカスタマーサービス取次店でご注文いただけます。
当社カスタマーサービスに直接ご注文する場合は、このカードの必要部品を○でかこみ代金を現金書留または、定額小為替(100円以下は切手可)と一緒に申し込みください。なお、ご送金にはタミヤカードや郵便振替もご利用いただけます。



Table listing parts and prices for the TRF414M kit, including items like Lower Deck, Upper Deck, A Parts, TA04 C Parts, etc.

Table listing parts and prices for the TRF414M kit, including items like Motor Plate, Front Bulkhead L, Front Bulkhead R, etc.

Table listing parts and prices for the TRF414M kit, including items like 2mm E-Ring, 2x10mm Shaft, Nylon Band, etc.

この他にも修理や整備のためのRCスペアパーツが発売されています。お近くの模型店店頭、または当社カスタマーサービスでお買い求めください。
ブルーの一部金属部品は限定商品のため小分け販売しておりません。ご注文いただいた場合シルバーの部品でお送りさせていただきます。

《郵便振替のご利用法》お近くの郵便局にある郵便払込用紙の通信欄にこのカードを参考にITEM番号、スケール、製品名、部品名、数量を必ずご記入ください。
振込人住所欄には電話番号もお書きいただき、口座番号・00810-9-1118、加入者名(株)タミヤでお振込ください。
《お問い合わせ番号》 静岡 054-283-0003
営業時間 東京 03-3899-3765 (静岡へ自動転送)
平日(月~金曜日) 8:00~20:00 土、日、祝日 8:00~17:00
For Japanese use only! ITEM 49255