





1/10 th SCALE NITRO TOURING CAR MSX 3 PARTS LIST



K0031 





K0032 

K0107

 K0107A 1pc.  K0107B 1pc.  K0108A 1pc.  K0109A 1pc.

K0107/1

 K0107/1A  K0107/1B

 S1A3x8 4pcs.
 S1x10 2pcs.
 S1x8 7pcs.
 SK3x3 2pcs.

T0114

 K0213A 2pcs.

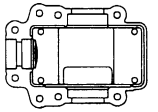
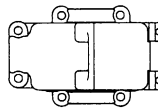

K0151

 K0151A 1pc.  K0151B 1pc.

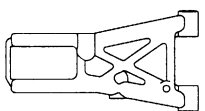
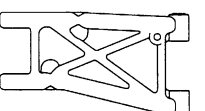
K0152

 K0152F 1pc.  K0152R 1pc.

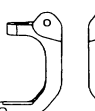
K0153

 K0153L 1pc.  K0153R 1pc.

K0154

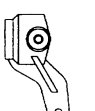
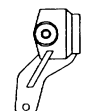
 K0154L 1pc.  K0154R 1pc.

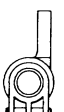
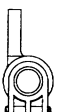

K0155

 K0155L 1pc.  K0155R 1pc.

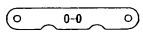
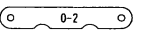
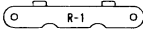
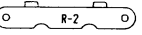
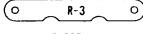
K0156

 0-0 K0156A 3pcs.  0-2 K0156B 2pcs.
 R-1 K0156C 1pc.  R-2 K0156D 1pc.
 R-3 K0156E 1pc.

K0157

 Lower Arm Pin S 2pcs.
 Lower Arm Pin M 2pcs.

K0203

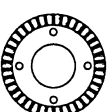
 K0203 1pc.

K0204

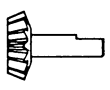
 K0204 1pc.

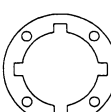

T0207

 T0207 4pcs.

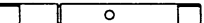

K0208

 K0208A 1pc.

K0209

 K0209A 1pc.  2x9.8 Pin 1pc.



T0210

 S5 O-Ring 5pcs.  S3 O-Ring 10pcs.  P3 O-Ring 2pcs.



K0212

 K0212A 4pcs.





K0214

 K0214A 4pcs.
 K0309A 3pcs.

C0227

 $\varnothing 3.5 \times \varnothing 7.5 \times 0.27$ 20pcs
 $\varnothing 5 \times \varnothing 10 \times 0.27$ 10pcs





C0228







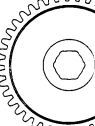

 C0222A 2pcs
 C0222B 4pcs
 C0222C 2pcs
 S-3 O-ring 4pcs

K0239 **OPT**

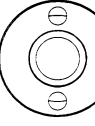
 K0239 1pc.

K0240 **OPT**

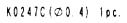
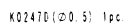
 K0241 1pc.  K0242 1pc.  K0243 1pc. $\varnothing 5 \times 8 \times 2.5$ タル 4pcs.
 OW(5x10x1) 1pc.

 K0244A 1pc.  K0244B 1pc.  K0246 1pc.
 K0244C 1pc.  K0239 1pc.  CTW-50 1pc.
 K0245 1pc.
 K0247C($\varnothing 0.4$) 1pc.
 K0247D($\varnothing 0.5$) 1pc.  K0247 1pc.
2mm六角レンチ

K0241 **OPT**

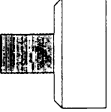
 K0241 1pc.



K0242 **OPT**

 K0242 1pc.

K0243 **OPT**

 K0243 1pc.

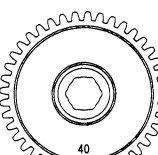
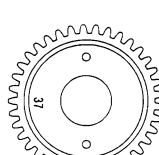

K0244 **OPT**

 K0244A 1pc.  K0244B 1pc.  K0244C 1pc.

K0245 **OPT**

 K0245 1pc.

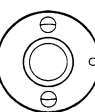
K0246 **OPT**

 K0246 1pc.  CTW-50 1pc.

K0247 **OPT**

 K0247 1pc.

K0031 INSTRUCTION MANUAL
 K0032 DECAL
 K0107 SPUR GEAR MOUNT A
 K0107/1 AL. SPUR GEAR MOUNT
 T0114 REAR LOWER ARM PIN
 K0151 GEAR BOX
 K0152 SUS. ARM
 K0153 FRONT UPRIGHT
 K0154 STEERING KNUCKLE
 K0155 REAR UPRIGHT
 K0156 SUS. MOUNT

K0157 LOWER ARM PIN
 K0203 RING GEAR
 K0204 BEVEL GEAR
 T0207 DIFF. GASKET
 K0208 SPUR GEAR 42T
 K0209 SPUR GEAR SHAFT
 T0210 O-RING SET
 K0212 KING PIN COLOR
 K0214 ROD 18mm/25mm
 C0227 SPACER
 C0228 DIFF. GEAR W/O-RING
 K0239 ONE WAY BEARING FOR 2 SPEED

K0240 2 SPEED GEAR SET
 K0241 CLUTCH BELL FOR 2 SPEED
 K0242 1ST. PINION GEAR 15T FOR 2 SPEED
 K0243 2ND. PINION GEAR 18T FOR 2 SPEED
 K0244 SPUR GEAR SET FOR 2 SPEED
 K0245 CENTER SHAFT FOR 2 SPEED
 K0246 2ND. GEAR HOUSING FOR 2 SPEED
 K0247 CHANGING DRIVE DISK FOR 2 SPEED

MSX 3 PARTS LIST

C0114

OW(5×10×1)×10
OW(13.5×15.9×0.2)×4
OW(3×8×0.5)×5

K0251

K0251A 1pc.
K0251B 1pc.

K0252

K0252 2pcs.

K0253

K0253 1pcs.
K0254 1pc.

K0255

K0255 1pc.
K0256 1pc.

K0257

K0257 2pcs.

K0258

K0258 2pcs.

C0308

C0308×2

K0351

K0351 1pc.
K0106A 4pcs.
K0352A 4pcs.
K0352B 2pcs.
K0352C 2pcs.
K0352D 2pcs.

K0353

K0353A 1pc.
K0353B 1pcs.

K0354

K0354A 1pc. K0354B 1pc. K0354C 1pc.
K0354D 4pcs.
K0354E 1pc. K0354F 1pc.

- C0114 WASHER SET
- K0251 DIFF. CASE
- K0252 DIFF. CUP JOINT
- K0253 CUP JOINT
- K0255 CENTER SHAFT
- K0257 F/R AXLE SHAFT
- K0258 F/R DRIVE SHAFT
- C0308 COMP. BRAKE DISK
- K0351 RADIO PLATE
- K0353 RECEIVER BOX
- K0354 SERVO SAVER PARTS A

K0355

K0355 2pcs. K0356 1pc.
K0357 1pc. K0358 1pc.
K0359 1pc.

K0360

K0304D 1pc.
K0307A 2pcs.
K0360 1pc.

ST-T35/T71

K0405 1pc.

K0451

K0451 1pc.

K0452

K0452A 1pc. K0452B 1pc. K0452C 1pc.

K0453

K0453A 1pc.
K0453F 2pcs.
K0453R 2pcs.

K0501/1

K0501A 4pcs.

K0501/2

K0501B 4pcs. K0501D 4pcs. K0501E 4pcs. K0501F 4pcs. K0501G 4pcs. K0501H 4pcs.
K0501I 4pcs. K0501J 4pcs. K0501L 4pcs. K0501P 4pcs.
K0501M 4pcs. K0501N 4pcs. K0501O 4pcs.

K0501/3

K0501C 4pcs.

K0501/5

K0501K 4pcs.

K0509

P3 O-Ring 8pcs.

K0510

K0510 2pcs.

- K0355 SERVO SAVER PARTS B
- K0360 BRAKE PARTS
- K0405 URETHANE BUMPER
- K0451 CHASSIS
- K0452 BUMPER
- K0453 BODY MOUNT
- K0501/1 DAMPER CASE
- K0501/2 DAMPER PART B
- K0501/3 DAMPER CAP B
- K0501/5 DAMPER SHAFT
- D0508 DIAPHRAGM
- K0509 O-RING P3
- K0510 DAMPER SPRING

C0502 **OPT**

C0502 4pcs

D0506 **OPT**

H 0506×2 (SN2.6)×2
(OW2.6×6×0.5)×2

D0508

D 0508×8

D0509 **OPT**

D 0509A×8 C 0509C×4
P3 O-Ring×8

H0510 **OPT**

D 0510F×2
D 0510R×2

J0511 **OPT**

J0511 2pcs

J0512 **OPT**

J0512 2pcs

H0513 **OPT**

D 0513×2 S12 O-Ring×2
O-Ring

D0514 **OPT**

D 0514×4

H0521 **OPT**

D 0503B×2 D 0513×2 D 0508×2 H 0510 F×2 D 0506×2
D 0503A×2 D 0507B×2 D 0507A×2 D 0514×2 D 0507C×2
D 0509A×2 P3 O-Ring×2 組込み済み
(S12 O-Ring)×2 (SG3×16)×2 (SN2.6)×2

H0522 **OPT**

D 0503B×2 D 0513×2 D 0508×2 H 0510 R×2 D 0506×2
D 0507A×2 D 0507B×2 D 0507C×2 D 0514×2
D 0503A×2 D 0509A×2 P3 O-Ring×2 組込み済み
(S12 O-Ring)×2 (SN2.6)×2

H0523 H0524
H0525 H0526 **OPT**

2pcs.

H0527 H0528 H0529
H0530 H0531 **OPT**

2pcs.

- H0521 FRONT DAMPER
- H0522 REAR DAMPER
- C0502 PIVOT BALL
- J0511 FRONT SPRING
- J0512 REAR SPRING
- D0506 REAR DAMPER SHAFT
- D0509 O-RING SET
- H0510 DAMPER PISTON
- H0513 SPRING ADJUSTER
- D0514 DAMPER PIVOT BALL
- H0523 FRONT DAMPER SPRING PURPLE φ 1.6mm
- H0524 FRONT DAMPER SPRING LIGHT BLUE φ 1.7mm
- H0525 FRONT DAMPER SPRING GRAY φ 1.8mm
- H0526 FRONT DAMPER SPRING WHITE φ 1.9mm
- H0527 REAR DAMPER SPRING PURPLE φ 1.6mm
- H0528 REAR DAMPER SPRING LIGHT BLUE φ 1.7mm
- H0529 REAR DAMPER SPRING GRAY φ 1.8mm
- H0530 REAR DAMPER SPRING WHITE φ 1.9mm
- H0531 REAR DAMPER SPRING PINK φ 2.0mm

1/10 th SCALE NITRO TOURING CAR MSX 3 PARTS LIST

H0551 **OPT**



D0507A 4pcs D0507B 4pcs D0507C 4pcs

K0551

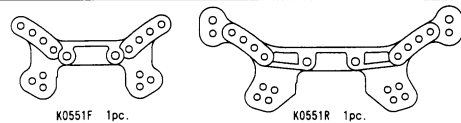

K0551F 1pc. K0551R 1pc.

C0602 **OPT**



C0602 × 4

K0603



K0603 (10X15x4) x2

K0603/1



K0603 (10X15x4) 10 pcs

K0604



(5 x 11 x 4) 2 pcs.

K0605



K0603×8 K0604×10

K0701

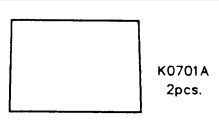

K0701A 2pcs.

K0702

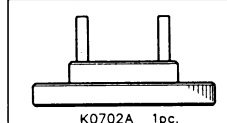

K0702A 1pc.

K0703

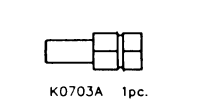

K0703A 1pc.

K0704

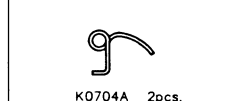

K0704A 2pcs.

K0705

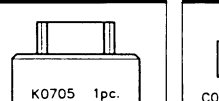

K0705 1pc.

C0705

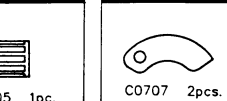

C0705 1pc.

K0707

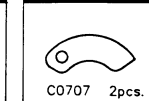

K0707 2pcs.

K0708 **OPT**

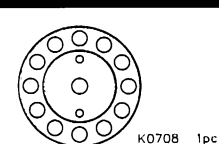

K0708 1pc

K0709 **OPT**

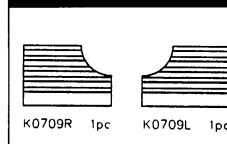

K0709R 1pc K0709L 1pc

K0710 **OPT**

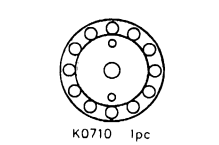

K0710 1pc

K0711 **OPT**

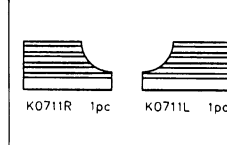

K0711R 1pc K0711L 1pc

H0551 DAMPER PLASTIC PART
 K0551 DAMPER STAY
 C0602 BEARING (5X8) 4pcs.
 K0603 BEARING (10X15) 2pcs.
 K0603/1 BEARING (10X15) 10pcs.
 K0604 BEARING (5X11) 2pcs.
 K0605 BEARING SET (K0603X8 K0604X10)
 K0701 ENGINE MOUNT
 K0702 FLYWHEEL
 K0703 ENGINE NUT
 K0704 CLUTCH SPRING
 K0705 CLUTCH BELL 15T
 C0705 NEEDLE ROLLER
 K0707 CLUTCH SHOE
 K0708 AL. FLYWHEEL φ40
 K0709 AL. ENGINE MOUNT 20mm
 K0710 AL. FLYWHEEL φ34
 K0711 AL. ENGINE MOUNT 16mm

K0802

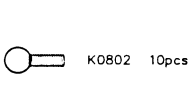

K0802 10pcs.

AS023

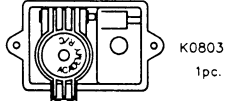

K0803 1pc.

K0806

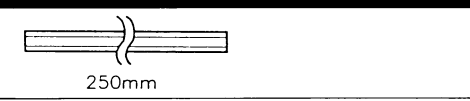

250mm

K0851

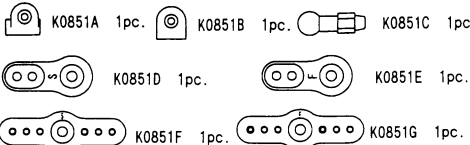

K0851A 1pc. K0851B 1pc. K0851C 1pc.
 K0851D 1pc. K0851E 1pc.
 K0851F 1pc. K0851G 1pc.

K0801

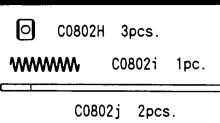

C0802H 3pcs.
 C0802i 1pc.
 C0802j 2pcs.

GRS-32

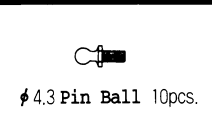

φ 4.3 Pin Ball 10pcs.

ST-T64

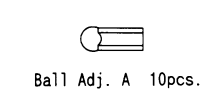

Ball Adj. A 10pcs.

ST-T65

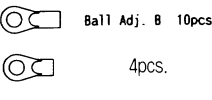

Ball Adj. B 10pcs.
 4pcs.

K0951

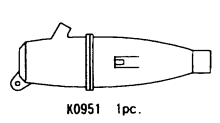

K0951 1pc.

K0952

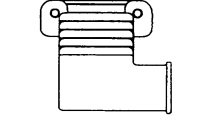

K0952 1pc.

H0851

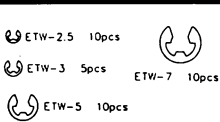

ETW-2.5 10pcs
 ETW-3 5pcs
 ETW-5 10pcs
 ETW-7 10pcs

H0855 **OPT**

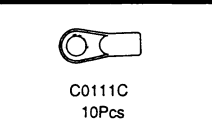

C0111C 10Pcs

H0856 **OPT**

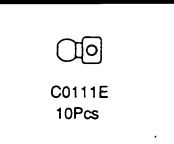

C0111E 10Pcs

C0901 **OPT**

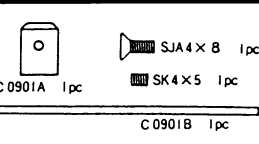

C0901A 1pc
 SJA 4 x B 1pc
 SK 4 x 5 1pc
 C0901B 1pc

K0802 PIN BALL B
 K0803 FUEL TANK
 K0806 ANTENNA PIPE
 K0851 LINKAGE PARTS A
 K0852 LINKAGE PARTS B
 GRS-32 φ 4.3 PIN BALL
 K0854 BALL ADJUST A
 K0855 BALL ADJUST B
 K0951 MUFFLER
 K0952 MANIFOLD
 H0851 E-RING SET
 H0855 BALL LINK φ6
 H0856 STABILIZER LINK BALL
 C0901 MUFFLER STAY

K1111 **K1111/1**
K1112 **K1113** **OPT**



K1114 **K1115**



K1114

K1117 **K1118** **OPT**



K1117

K1120 **OPT**

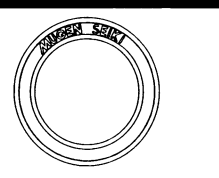

K1122 **OPT**

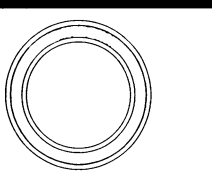

K1123 **OPT**

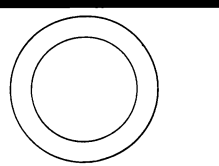

K1124 **OPT**

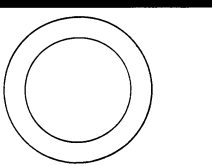

K1130 **OPT**

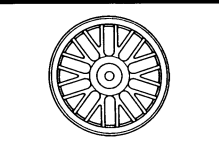

K1131 **OPT**

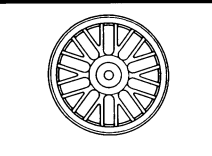



■ 직매점 겸 A/S센터 방배동:552-9293, 삼선교:742-9293, 수유동:902-9293, 아שמ비센터:6002-6293, 양재동:575-9997, 용산:796-1214
 ■ A/S센터 본사:908-7000(교환 147), 동대문:745-9293, 천호동:473-9293
 ■ 총판점 겸 A/S 센터 강남아카데미:485-6884, 강북아카데미:762-0980, 경기아카데미:(031)458-5591, 노원아카데미:907-0940, 대구아카데미:(053)744-9293, 부산아카데미:(051)293-7449, 양천아카데미:691-7108
 ♣ 고객센터문의 080-969-7000(수신자부담)
 ■ 홈페이지 http://www.academyhobby.com

K1111/1 MESH WHEELS WHITE (8pcs.)
 K1111 MESH WHEELS WHITE
 K1112 MESH WHEELS BLACK
 K1113 MESH WHEELS SILVER
 K1114 6 SPOKE WHEELS WHITE
 K1115 6 SPOKE WHEELS GOLD
 K1116 6 SPOKE WHEELS GREEN
 K1117 FIN-TYPE WHEELS WHITE
 K1118 FIN-TYPE WHEELS SILVER
 K1120 SLICK TIRES & INNER FOAM
 K1122 RADIAL TIRES & INNER FOAM
 K1123 INNER FOAM (RING TYPE/4pcs.)
 K1124 INNER FOAM HARD (RING TYPE/4pcs.)
 K1130 6 SPOKE WHEELS WHITE (4pcs.)
 K1131 6 SPOKE WHEELS WHITE (8pcs.)

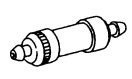
MSX 3 PARTS LIST

B0104 OPT  B0104 x 1

B0111  B0111 1pc.  B0112 1pc. 90mm 1pc.

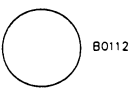
B0112  B0112 4pcs.

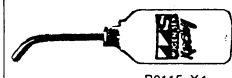
B0115 OPT  B0115 x 1

B0203 OPT  B 0203 x 1

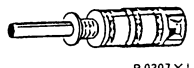
B0207 OPT  B 0207 x 1

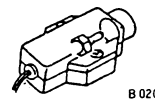
B0208 OPT  B 0208 x 1

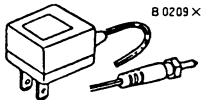
B0209 OPT  B 0209 x 1

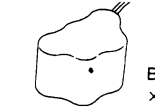
B0211 OPT  B0211 x 1

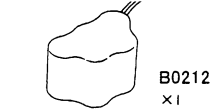
B0212 OPT  B0212 x 1

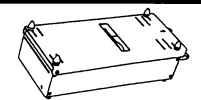
B0230 OPT  B 0230 x 1

B0301 OPT  B 0301 x 1

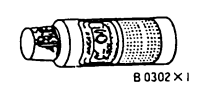
B0302 OPT  B 0302 x 1

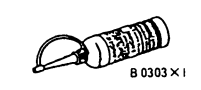
B0303 OPT  B 0303 x 1

B0306 OPT  B 0306 x 1

B0308 OPT  B0308x1

B0310 B0315 B0320 B0325
B0311 B0316 B0321 B0326
B0312 B0317 B0322 B0327
B0313 B0318 B0323 B0328
B0314 B0319 B0324 OPT



B0406 OPT  B0406 x 2

B0407 OPT  B 0407 x 15

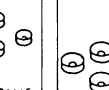
B0408 OPT  B 0408 x 15

B0410 B0411 B0412 OPT  B 0410 Pink x 1
B 0411 Green x 1
B 0412 Yellow x 1

B0415 OPT  Pink x 1
Green x 1
Yellow x 1

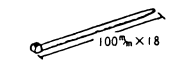
B0416 OPT  100% x 18

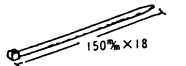
B0417 OPT  150% x 18

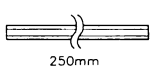
B0420  250mm

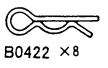
B0422  B0422 x 8

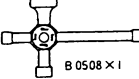
B0508 OPT  B 0508 x 1

B0509 OPT  B 0509 x 1

B0510 OPT  B 0510 x 1

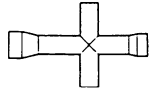
B0512 

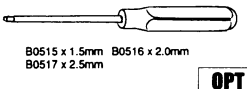
B0515 B0516 B0517 OPT  B0515 x 1.5mm
B0516 x 2.0mm
B0517 x 2.5mm

B0610  SL3x10

B0611  SL3x12

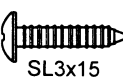
B0612  SL3x15

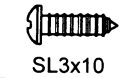
B0620  SL3x10

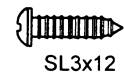
B0621  SL3x12

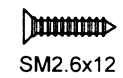
B0630  SM2.6x12

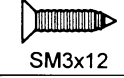
B0635  SM3x12

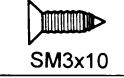
B0636  SM3x10

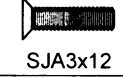
B0642  SJA3x12

B0645  SJA4x8

B0650  SI3x10

B0651  SI3x12

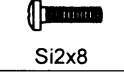
B0652  SI2x8

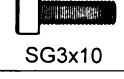
B0660  SG3x10

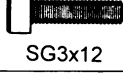
B0663  SG3x12

B0664  SG3x16

B0670  SK3x3

B0672  SK3x12

B0673  SK3x8

B0680  SK4x4

B0711  SN4

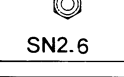
B0712  SN2.6

B0713  SN3

B0714  SN4

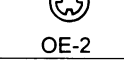
B0720  OE-2

B0721  OE-4

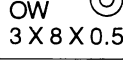
B0723  OW 3 X 8 X 0.5

- B0104 FUEL FILTER S
- B0111 AIR FILTER SET
- B0112 AIR FILTER
- B0115 FUEL PUMP
- B0203 QUICK BOOSTER
- B0207 POCKET BOOSTER
- B0208 ADAPTER FOR POCKET BOOSTER
- B0209 BATTERY FOR POCKET BOOSTER
- B0211 POWER PACK 900 W/FUTABA 2+3
- B0212 POWER PACK 900 W/SANWA 2+3
- B0230 PRO STARTER BII
- B0301 LOCK FIRM LIQUID
- B0302 AIR FILTER OIL
- B0303 ENGINE MAINTENANCE OIL
- B0306 RAD REZ
- B0308 SUPER GREASE
- B0310 SUPER SILICON #100
- B0311 SUPER SILICON #150
- B0312 SUPER SILICON #200
- B0313 SUPER SILICON #250
- B0314 SUPER SILICON #300
- B0315 SUPER SILICON #350
- B0316 SUPER SILICON #400
- B0317 SILICON FOR DIFF. #10000
- B0318 SILICON FOR DIFF. #30000
- B0319 SILICON FOR DIFF. #50000
- B0320 SILICON FOR DIFF. #100000
- B0321 SILICON FOR DIFF. #3000
- B0322 SILICON FOR DIFF. #5000
- B0323 SILICON FOR DIFF. #7000
- B0324 SILICON FOR DIFF. #1000
- B0325 SUPER SILICON #500
- B0326 SUPER SILICON #600
- B0327 SUPER SILICON #700
- B0328 SUPER SILICON #800
- B0406 BOTH SIDE TAPE
- B0407 FLAT WASHER 3mm
- B0408 FLAT WASHER 4mm
- B0410 COLOR SILICON PIPE PINK
- B0411 COLOR SILICON PIPE GREEN
- B0412 COLOR SILICON PIPE YELLOW
- B0415 MUFFLER JOINT SILICON PIPE S
- B0416 COLOR STRAP SET 100mm
- B0417 COLOR STRAP SET 150mm
- B0420 FUEL PIPE
- B0422 BODY PIN
- B0506 SNAP RING PLIERS
- B0508 UTILITY WRENCH
- B0509 SETTING DRIVER FOR ENGINE
- B0510 CAMBER GAUGE
- B0512 CROSS WRENCH
- B0515 WORKS WRENCH 1.5mm
- B0516 WORKS WRENCH 2.0mm
- B0517 WORKS WRENCH 2.5mm
- B0610 SL3X10 B/H TAPPING SCREW
- B0611 SL3X12 B/H TAPPING SCREW
- B0612 SL3X15 B/H TAPPING SCREW
- B0620 SL3X10 R/H SCREW
- B0621 SL3X12 R/H SCREW
- B0630 SM2.6X12 F/H TAPPING SCREW
- B0635 SM3X12 F/H TAPPING SCREW
- B0636 SM3X10 F/H TAPPING SCREW
- B0642 SJA3X12 F/H SCREW
- B0645 SJA4X8 F/H SCREW
- B0650 SI3X10 SCREW
- B0651 SI3X12 SCREW
- B0652 SI2X8 SCREW
- B0653 SM3X10 SCREW
- B0660 SG3X10 CAP SCREW
- B0663 SG3X12 CAP SCREW
- B0664 SG3X16 CAP SCREW
- B0670 SK3X3 SET SCREW
- B0672 SK3X12 SET SCREW
- B0673 SK3X8 SET SCREW
- B0680 SK4X4 SET SCREW
- B0713 SN3 NYLON NUT (10pcs.)
- B0714 SN4 NYLON NUT (10pcs.)
- B0711 SN4 NYLON NUT W/FLANGE (10pcs.)
- B0712 SN2.6 NYLON NUT (10pcs.)
- B0720 OE-2 E-RING
- B0721 OE-4 E-RING
- B0723 OW3X8X0.5 WASHER



(주) 아카데미과학
ACADEMY PLASTIC MODEL CO., LTD.
 서울시 강북구 수유2동 273-64 ☎(02)908-7000