

O.S. ENGINE**MAX-15CV-A, 25FX, 32SX**

OWNER'S INSTRUCTION MANUAL

It is of vital importance, before attempting to operate your engine, to read the general **'SAFETY INSTRUCTIONS AND WARNINGS'** section on pages 2-6 of this booklet and to strictly adhere to the advice contained therein.

- Also, please study the entire contents of this instruction manual, so as to familiarize yourself with the controls and other features of the engine.
- Keep these instructions in a safe place so that you may readily refer to them whenever necessary.
- It is suggested that any instructions supplied with the aircraft, radio control equipment, etc., are accessible for checking at the same time.

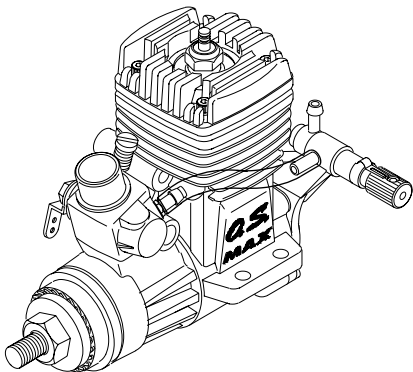

CONTENTS

| | | | |
|---|-------|---|-------|
| SAFETY INSTRUCTIONS AND WARNINGS ABOUT YOUR O.S. ENGINE----- | 2~6 | RUNNING-IN (Breaking-in) ----- | 17~19 |
| INTRODUCTION, BEFORE INSTALLING THE ENGINE----- | 7 | IDLING ADJUSTMENT CHART ----- | 20 |
| BASIC ENGINE PARTS CARBURETOR PARTS ----- | 8 | MIXTURE CONTROL VALVE ADJUSTMENT, REALIGNMENT OF MIXTURE CONTROL VALVE ----- | 21 |
| INSTALLATION OF THE ENGINE----- | 9 | SUBSEQUENT STARTING PROCEDURE SUBSEQUENT READJUSTMENT ----- | 22 |
| THROTTLE LINKAGE, SILENCER----- | 10~11 | CARBURETOR CLEANLINESS, ENGINE CARE AND MAINTENANCE ----- | 23 |
| FUEL TANK LOCATION ----- | 11 | GENUINE O.S. PARTS & ACCESSORIES ---- | 24~25 |
| GLOWPLUG ----- | 12 | ENGINE EXPLODED VIEWS & ENGINE PARTS LISTS ----- | 26~29 |
| FUEL, PROPELLERS----- | 13~14 | CARBURETOR EXPLODED VIEWS & PARTS LISTS ----- | 30~31 |
| MIXTURE CONTROLS----- | 14 | ENGINE THREE VIEW DRAWING ---- | 31~32 |
| BEFORE STARTING----- | 14~16 | | |
| STARTING ----- | 16~17 | | |

SAFETY INSTRUCTIONS AND WARNINGS ABOUT YOUR O.S. ENGINE

Remember that your engine is not a "toy", but a highly efficient internal-combustion machine whose power is capable of harming you, or others, if it is misused.

As owner, you, alone, are responsible for the safe operation of your engine, so act with discretion and care at all times.

If at some future date, your O.S. engine is acquired by another person, we would respectfully request that these instructions are also passed on to its new owner.

- The advice which follows is grouped under two headings according to the degree of damage or danger which might arise through misuse or neglect.



WARNINGS

These cover events which might involve serious (in extreme circumstances, even fatal) injury.



NOTES

These cover the many other possibilities, generally less obvious sources of danger, but which, under certain circumstances, may also cause damage or injury.



WARNINGS

- Never touch, or allow any object to come into contact with, the rotating propeller and do not crouch over the engine when it is running.



- A weakened or loose propeller may disintegrate or be thrown off and, since propeller tip speeds with powerful engines may exceed 600 feet(180 metres) per second, it will be understood that such a failure could result in serious injury, (see 'NOTES' section relating to propeller safety).

- Model engine fuel is poisonous. Do not allow it to come into contact with the eyes or mouth. Always store it in a clearly marked container and out of the reach of children.



- Model engine fuel is also highly flammable. Keep it away from open flame, excessive heat, sources of sparks, or anything else which might ignite it. Do not smoke or allow anyone else to smoke, near to it.



- Never operate your engine in an enclosed space. Model engines, like automobile engines, exhaust deadly carbon-monoxide. Run your engine only in an open area.

- Model engines generate considerable heat. Do not touch any part of your engine until it has cooled. Contact with the muffler (silencer), cylinder head or exhaust header pipe, in particular, may result in a serious burn.





NOTES

- This engine was designed for model aircraft. Do not attempt to use it for any other purpose.
- Mount the engine in your model securely, following the manufacturers' recommendations, using appropriate screws and lock-nuts.
- Be sure to use the silencer (muffler) supplied with the engine. Frequent exposure to an open exhaust may eventually impair your hearing. Such noise is also likely to cause annoyance to others over a wide area.
- If you remove the glowplug from the engine and check its condition by connecting the battery leads to it, do not hold the plug with bare fingers. Use an appropriate tool or a folded piece of cloth.
- Install a top-quality propeller of the diameter and pitch specified for the engine and aircraft. Locate the propeller on the shaft so that the curved face of the blades faces forward-i.e. in the direction of flight. Firmly tighten the propeller nut, using the correct size wrench.



NOTES

- Always check the tightness of the propeller nut and retighten it, if necessary, before restarting the engine, particularly in the case of four-stroke-cycle engines. If a safety locknut assembly is provided with your engine, always use it. This will prevent the propeller from flying off in the event of a "backfire", even if it loosens.
- If you fit a spinner, make sure that it is a precision made product and that the slots for the propeller blades do not cut into the blade roots and weaken them.
- Preferably, use an electric starter. The wearing of safety glasses is also strongly recommended.
- Discard any propeller which has become split, cracked, nicked or otherwise rendered unsafe. Never attempt to repair such a propeller: destroy it. Do not modify a propeller in any way, unless you are highly experienced in tuning propellers for specialized competition work such as pylon-racing.
- Take care that the glow plug clip or battery leads do not come into contact with the propeller. Also check the linkage to the throttle arm. A disconnected linkage could also foul the propeller.
- After starting the engine, carry out any needle-valve readjustments from a safe position behind the rotating propeller. Stop the engine before attempting to make other adjustments to the carburetor.



NOTES

- Adjust the throttle linkage so that the engine stops when the throttle stick and trim lever on the transmitter are fully retarded. Alternatively, the engine may be stopped by cutting off the fuel supply. Never try to stop the engine physically.
- Take care that loose clothing (ties, shirt sleeves, scarves, etc.) do not come into contact with the propeller. Do not carry loose objects (such as pencils, screwdrivers, etc.) in a shirt pocket from where they could fall through the propeller arc.
- Do not start your engine in an area containing loose gravel or sand. The propeller may throw such material in your face and eyes and cause injury.
- For their safety, keep all onlookers (especially small children) well back (at least 20 feet or 6 meters) when preparing your model for flight. If you have to carry the model to the take-off point with the engine running, be especially cautious. Keep the propeller pointed away from you and walk well clear of spectators.
- Warning! Immediately after a glowplug-ignition engine has been run and is still warm, conditions sometimes exist whereby it is just possible for the engine to abruptly restart if the propeller is casually flipped over compression WITHOUT the glowplug battery being reconnected. Remember this if you wish to avoid the risk of a painfully rapped knuckle!

INTRODUCTION

- This range of engines is ideally suited to a variety of R/C aircraft, including trainer, sports, aerobatic and scale types.
- A separate precision-made needle-valve unit is installed at the rear, where manual adjustment is safely remote from the rotating propeller.

Note :

With these engines, the piston will feel tight at the top of its stroke when the engine is cold. This is normal. The piston and cylinder are designed to achieve a perfect running clearance when they reach their intended running temperature.

BEFORE INSTALLING THE ENGINE

Installing the glowplug

Carefully insert plug, with washer, fingertight only, before final tightening with the correct size plug wrench.

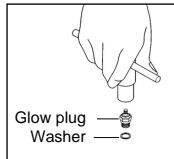

Connecting fuel tubing

Connect the short length of fuel tubing (supplied) securely between the needle-valve outlet and carburetor inlet as shown in the illustration on the next page.

In the event of the tubing becoming damaged, it should be replaced with a suitable length (as indicated below) of best quality 5mm ODx2mm ID silicone tubing. Use similar material to connect the fuel inlet nipple to the fuel tank.

| Length | |
|--------|------|
| 15CV-A | 44mm |
| 25FX | 38mm |
| 32SX | 44mm |

BASIC ENGINE PARTS

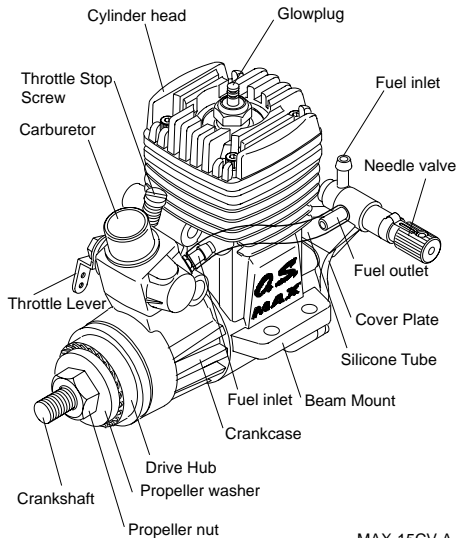

MAX-15CV-A

INSTALLATION OF THE CARBURETTOR

For 15CV-A

1. Loosen the retainer screw, rotate the carburettor to its correct position and make sure that it is pressed well down into the intake boss, compressing the rubber gasket, before retightening screw.
2. Rotate the retainer screw gently until it stops, then tighten a further 60-90°.
Do not overtighten the screw as this will damage the carburettor body.

Rotate the retainer nut gently until it stops.

Tighten a further 60-90°

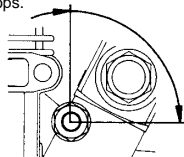

INSTALLATION OF THE ENGINE

Installation in the model

A typical method of beam mounting is shown below, left. O.S. radial motor mount (Available as an optional extra part. See parts list)

Rigid hardwood (e.g. maple)

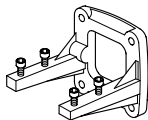
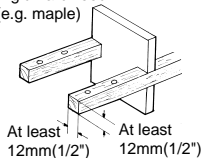

| | |
|-----------|-----------------------------------|
| 15CV-A | For CZ, 15CV-A(Code No. 71909410) |
| 25FX/32SX | For 25FX·32SX(Code No. 71908410) |

| Retaining Screw Size | |
|----------------------|-------|
| 15CV-A | 3.0mm |
| 25FX | 3.0mm |
| 32SX | 3.0mm |

Make sure that the mounting beams are parallel and that their top surfaces are in the same plane.

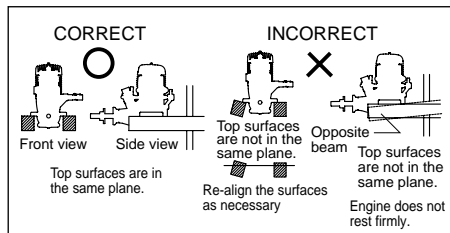

How to fasten the mounting screws.

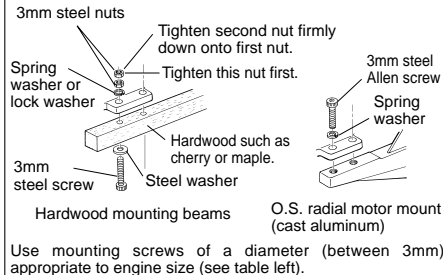

THROTTLE LINKAGE

- Before connecting the throttle-lever / servo linkage, make sure that no part of the linkage interferes with the internal structure of the aircraft or wiring, etc., when the throttle is fully open or fully closed.
- Set the throttle lever linkage so that the throttle rotor is (a) fully open when the transmitter throttle stick is fully advanced and (b) fully closed when the throttle stick is fully retarded.

Adjustment of the throttle rotor opening at the idling position can then be made with the throttle trim lever on the transmitter.

(Select throttle-lever and servo-horn hole positions that will avoid excessive pushrod travel causing the throttle to bind at either end.)

Note:

When adjusting the throttle lever angle, relative to the rotor, hold the rotor at about half-way between the open and closed positions while loosening and tightening the fixing screw, otherwise the rotor, rotor guide screw, throttle stop screw or carburettor body may become burred and damaged.

SILENCER

The exhaust outlet of the silencer can be rotated to any desired position in the following manner:

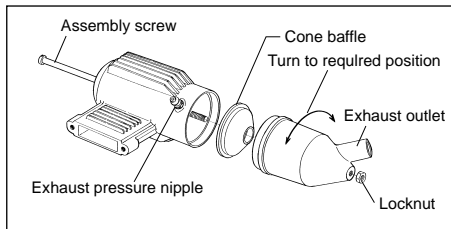

- 1) Loosen the locknut and assembly screw.
- 2) Set the exhaust outlet at the required position by rotating the rear part of the silencer.
- 3) Re-tighten the assembly screw, followed by the locknut.

NOTE :

The standard expansion-chamber type silencer is quite effective, but reduces power to some degree.

Reminder!

Model engines generate considerable heat. Do not touch any part of your engine until it has cooled.



Contact with the muffler (silencer), cylinder head or exhaust header pipe, in particular, may result in a serious burn.

Keep your hands and face away from exhaust gas or you will suffer a burn.

FUEL TANK LOCATION

Suggested fuel tank capacities are listed opposite.

These will allow 12-13 minute flights.

Locate the fuel tank so that the top of the tank is 5-10mm (1/4-3/8") above the level of the needle-valve.

- Be sure to use a pressurized fuel system by connecting the muffler pressure nipple to the vent-pipe of the fuel tank.

Suggested Fuel Tank Capacities

| | |
|--------|--------------|
| 15CV-A | approx 100cc |
| 25FX | approx 200cc |
| 32SX | approx 220cc |

Attention to tank height

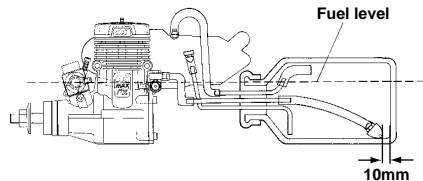

GLOWPLUG

Since the glowplug and fuel combination used may have a marked effect on performance and reliability, it would be worthwhile to experiment with different plug types.

Recommended O.S. plugs are A3 and Nos. 8.

Carefully install plug finger-tight, before final tightening with the correct size plug wrench.

The role of the glowplug

With a glowplug engine, ignition is initiated by the application of a 1.5-volt power source. When the battery is disconnected, the heat retained within the combustion chamber remains sufficient to keep the plug filament glowing, thereby continuing to keep the engine running. Ignition timing is 'automatic' : under reduced load, allowing higher rpm, the plug becomes hotter and, appropriately, fires the fuel/air charge earlier; conversely, at reduced rpm, the plug become cooler and ignition is retarded.

Glowplug life

Particularly in the case of very high performance engines, glowplugs must be regarded as expendable. However, plug life can be extended and engine performance maintained by careful use, i.e.:

- Install a plug suitable for the engine.
- Use fuel containing a moderate percentage of nitromethane unless more is essential for racing events.
- Do not run the engine too lean and do not leave the battery connected while adjusting the needle.

When to replace the glowplug

Apart from when actually burned out, a plug may need to be replaced because it no longer delivers its best performance, such as when:

- Filament surface has roughened and turned white.
- Filament coil has become distorted.
- Foreign matter has adhered to filament or plug body has corroded.
- Engine tends to cut out when idling.
- Starting qualities deteriorate.

FUEL

Select, by practical tests, the most suitable fuel from among the best quality fuels available in your country for model use. For the best performance, a fuel containing 5% to 20% nitromethane is preferable. Lubricants may be either castor-oil or a suitable synthetic oil (or a blend of both) provided that they are always of top quality.

For consistent performance and long engine life, it is essential to use fuel containing AT LEAST 18% lubricant by volume. Some fuels containing coloring additives tend to deteriorate and may adversely affect running qualities.

Once a satisfactory fuel has been selected and used for a while, it may be unwise to needlessly change the brand or type. In any engine, a change of fuel may cause carbon deposits in the combustion chamber or on the piston head to become detached and lodged elsewhere, with the risk of this causing unreliable operation for a while. If, however, the adoption of a different fuel is unavoidable, check the engine for the first few flights on the new fuel, by temporarily reverting to the running-in procedure.

Reminder!



Model engine fuel is poisonous. Do not allow it to come into contact with the eyes or mouth. Always store it in a clearly marked container and out of the reach of children.

Reminder!



Model engine fuel is also highly flammable. Keep it away from open flame, excessive heat, sources of sparks, or anything else which might ignite it. Do not smoke, or allow anyone else to smoke, near to it.

PROPELLERS

Suggested propeller sizes are listed on page 14. The suitability of the prop depends on the size and weight of the model and type of flying. Determine the best size and type after the engine has been run in. Check the balance of the propeller before fitting it to the engine. Unbalanced propellers cause vibration and loss of power. Wooden propellers are to be preferred. Some nylon propellers are not strong enough to withstand the high power output of these engines and a thrown blade can be very dangerous.

| | Sport | Aerobatic |
|---------------|------------------|------------------|
| 15CV-A | 8x4~6,8x4~6,9x4 | 8x4~6 |
| 25FX | 9x5~6,9.5x5,10x5 | 9x6,9.5x5 |
| 32SX | 10x6,10.5x5,11x6 | 9x7~8,10x6 |

Reminder!



Never touch, or allow any object to come into contact with, the rotating propeller and do not crouch over the engine when it is running.

MIXTURE CONTROLS

Two mixture controls are provided on these engines.

- **The Needle Valve (at rear of engine)**

When set to produce maximum power at full throttle, this establishes the basic fuel/air mixture strength. The correct mixture is then maintained by the carburetor's built-in automatic mixture control system to cover the engine's requirements at reduced throttle settings.

- **The Mixture Control Valve (carburetor)**

This meters fuel flow at part-throttle and idling speeds to ensure reliable operation as the throttle is opened and closed. The Mixture Control Valve is factory set for the approximate best result. First run the engine as received and readjust the Mixture Control Screw only if necessary.

Type of Carburetor

| | |
|--------|-----|
| 15CV-A | 10K |
| 25FX | 20D |
| 32SX | 20F |

BEFORE STARTING

Tools, accessories, etc.

The following items are necessary for operating the engine.

1 Fuel

Model glowplug engine fuel of good quality, preferably containing a small percentage of nitromethane.

2 Glowplug

O.S. A3 and No.8 glowplug is fitted to the engine.

3 Propeller

Suggested size is 7x5-6(15CV-A), 9X5-6 (25FX), or 10X6 (32SX).

4 Glowplug battery

The power source for heating the glowplug may be either a large heavy-duty 1.5volt dry cell, or preferably, a 2-volt rechargeable lead-acid cell (accumulator).

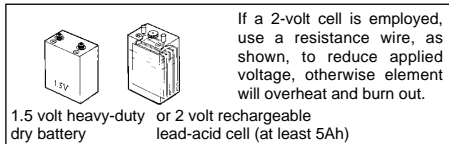

Warning (Very hot)

Never touch the nichrome wire while the battery is connected.

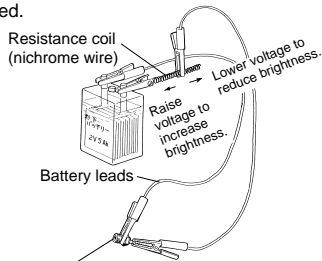

Adjust applied voltage by changing the position of clip on resistance coil until glowplug element is glowing bright red.

5 Battery leads

These are used to conduct current from the battery to the glowplug. Basically, two leads, with clips, are required, but, for greater convenience, twin leads with special glowplug connectors, as shown on the right, are commercially available.



6 Fuel tank

For installation in the model, a 100cc(3.5oz.) for 15CV-A, a 200cc(7oz.) for 25FX, a 240cc(8.5oz.) for 32SX tank, is suggested.

7 Fuel bottle or pump

For filling the fuel tank, a simple, polyethylene "squeeze" bottle, with a suitable spout, is all that is required. Alternatively, one of the purpose-made manual or electric fuel pumps may be used to transfer fuel directly from your fuel container to the fuel tank.



Fuel pumps

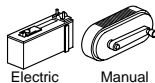

8 Electric starter and starter battery

An electric starter is recommended for starting.

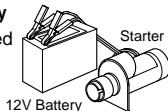

9 Fuel can filter

Fit a filter to the outlet tube of your refuelling container to prevent entry of foreign matter into the fuel tank.

Fuel Can Filter



10 Silicone tubing

This is required for the connection between the fuel tank and engine.

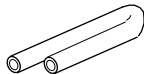

11 Plug wrench

Used for tightening glowplug. The O.S. long plug wrench is available as an optional accessory.

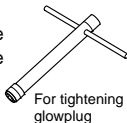

For tightening glowplug

STARTING

1. Install appropriate propeller and tighten securely.
2. To facilitate electric starting, install an O.S. solid aluminium alloy spinner-nut for centering the rubber drive insert of the starter. Alternatively, a good quality spinner, enclosing the propeller boss, may be used, but make sure that it is of precision-made and sturdy construction so that the spinner shell cannot loosen when the starter is used. Close the throttle.

3. Fill the fuel tank. Do not allow fuel to overflow into the silencer, otherwise the engine may become flooded and difficult to start.
4. Check that the needle-valve is closed. (Do not overtighten.) Now open the needle-valve counter-clockwise to the starting setting:-
 - $2\frac{1}{2}$ ~3 turns for 15CV-A
 - $1\frac{1}{2}$ ~2 turns for 25FX
 - $1\frac{1}{2}$ turns for 32SX

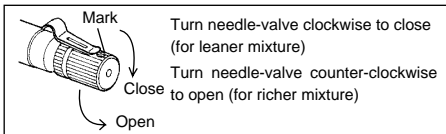

5. Open the throttle approx. one-quarter.

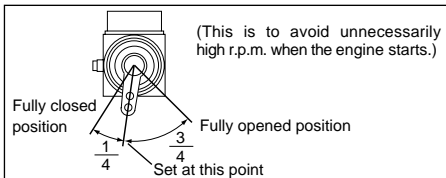

6. Connect battery leads to glowplug.
7. Bring electric starter into contact with spinner-nut or spinner and depress starter switch for one or two seconds. Repeat if necessary.
When the engine starts, withdraw the starter immediately.

Attention :

Do not choke the carburettor air intake when applying the starter. This could cause an excessive amount of fuel to be drawn into the cylinder which may initiate an hydraulic lock and damage the engine.

If the engine does not start within 10 repeat applications of the starter, remove the glow-plug, check that it glows brightly and that the cylinder is not flooded with fuel. (To eject excess fuel, close needle-valve and apply starter with glowplug removed.) Then try again.

VERY IMPORTANT!

Before being operated at full power (i.e. at full-throttle and with the needle-valve closed to its optimum setting) the engine must be adequately run-in, otherwise there is a danger of it becoming overheated and damaged.

RUNNING-IN ("Breaking-in")

All internal-combustion engines benefit from extra care when they are run for the first few times known as running-in or breaking-in.

This allows the working parts to mate together under load at operating temperature. Therefore, it is vitally important to complete the break-in before allowing the engine to run continuously at high speed and before finalizing carburetor adjustments.

However, because O.S. engines are produced with the aid of the finest modern precision machinery and from the best and most suitable materials, only a short and simple running-in procedure is called for and can be carried out with the engine installed in the model. The process is as follows.

1. Install the engine with the propeller intended for your model. Open the needle-valve to the advised starting setting and start the engine. If the engine stops when the glow plug battery disconnected, open the needle-valve to the point where the engine does not stop. Run the engine for one minute with the throttle fully open, but with the needle-valve adjusted for rich, slow "four-cycle" operation.

2. Now close the needle-valve until the engine speeds up to "two-cycle" operation and allow it to run for about 10 seconds, then reopen the needle-valve to bring the engine back to "four-cycle" operation and run it for another 10 seconds. Repeat this procedure until the fuel tank is empty.
3. Re-start and adjust the needle-valve so that the engine just breaks into "two-cycle" from "four-cycle" operation, then make three or four flights, avoiding successive "nose-up" flights.
4. During subsequent flights, the needle-valve can be gradually closed to give more power. However, if the engine shows signs of running too lean, the next flight should be set rich. After a total of ten to fifteen flights, the engine should run continuously, on its optimum needle-valve setting, without loss of power as it warms up.
5. After the completion of the running-in adjust the carburetor at optimum setting referring to MIXTURE CONTROL VALVE ADJUSTMENT section and SUBSEQUENT READJUSTMENT section.

Optimum needle setting(1)

Slowly advance the throttle to its fully open position, then gradually close the needle-valve until the exhaust note begins to change. (4-cycle to 2-cycle) At this point, disconnect the battery from the glowplug, taking care that the battery leads or glowplug clip do not come into contact with the rotating propeller. If the engine stops when the battery is disconnected, close the needle-valve about 30° and restart.

Optimum needle setting(2)

As the needle-valve is closed slowly and gradually, the engine r.p.m. will increase and a continuous high-pitched exhaust note, only, will be heard. Close the needle-valve 10-15° and wait for the change of r.p.m. After the engine r.p.m. increases turn the needle-valve another 10-15° and wait for the next change of r.p.m. As the speed of the engine does not instantly change with needle-valve readjustment, small movements, with pauses between, are necessary to arrive at the optimum setting.

Needle-valve adjustment diagram

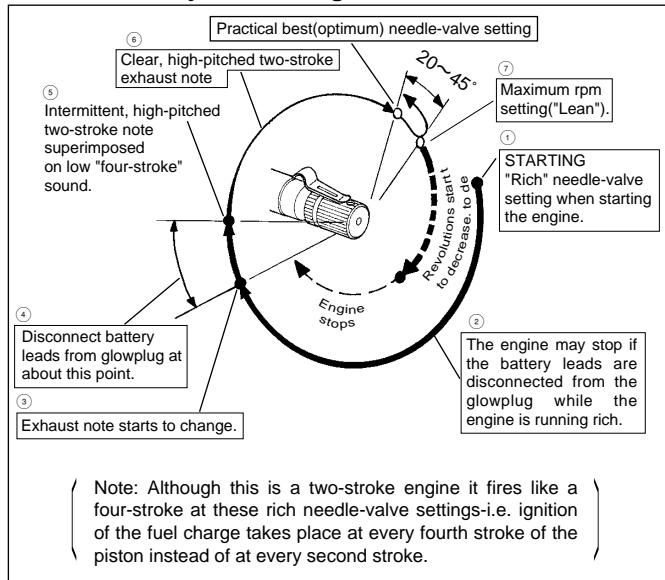

Note :

This diagram is for reference purposes only. Actual needle positions may differ from those shown.

- To stop the engine, close the throttle completely to cut off fuel/air supply.

IDLING ADJUSTMENT CHART

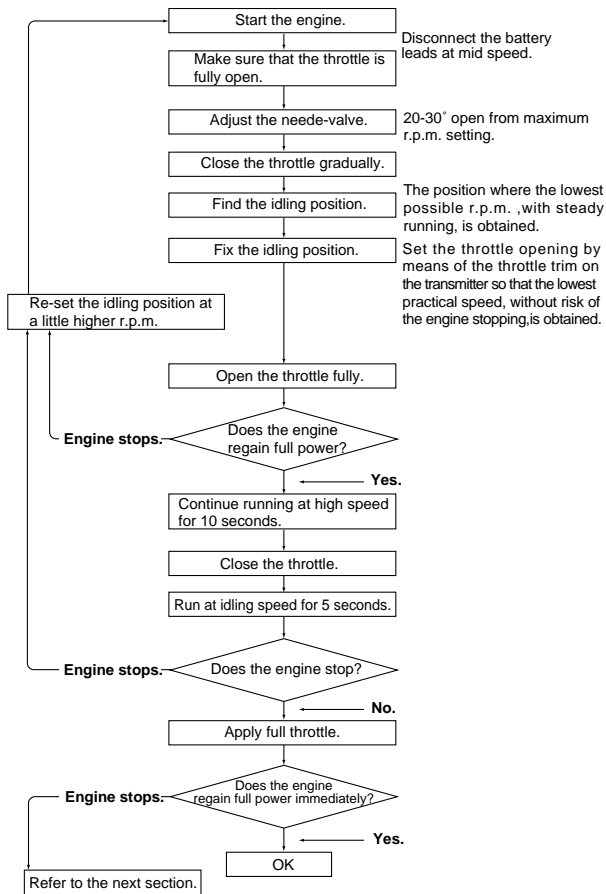

MIXTURE CONTROL VALVE ADJUSTMENT

With the engine running, close the throttle and allow it to idle for about five seconds, then open the throttle fully. If, at this point, the engine is slow to pick up and produces an excess of exhaust smoke, the mixture is too rich. Correct this condition by turning the Mixture Control Screw clockwise 15-30°. If the mixture is excessively rich, engine rpm will become unstable: opening the throttle will produce a great deal of smoke and rpm may drop suddenly or the engine may stop. This condition may also be initiated by excessively prolonged idling.

If, on the other hand, the mixture is too lean, this will be indicated by a marked lack of exhaust smoke and a tendency for the engine to cut out when the throttle is opened. In this case, turn the Mixture Control Screw counter-clockwise 90° to positively enrich the idle mixture, then turn the screw clockwise gradually until the engine regains full power cleanly when the throttle is reopened.

Carry out adjustments patiently until the engine responds quickly and positively to the throttle control.

Note: Mixture Control Valve adjustments should be made in steps of 15-30° initially, carefully checking the effect, on throttle response, of each small adjustment.

REALIGNMENT OF MIXTURE CONTROL VALVE

In the course of making carburetor adjustments, it is just possible that the Mixture Control Valve may be inadvertently screwed in or out too far and thereby moved beyond its effective adjustment range.

Its basic setting can be re-established as follows:

Close the throttle rotor gradually from the fully opened position until it is just fully closed.

(Do not turn further.) Then, screw in the Mixture Control Screw until it stops. Now unscrew the Mixture Control Screw as indicated below.

| | |
|---------------|------------------------------|
| 15CV-A | approx 1 $\frac{2}{3}$ turns |
| 25FX | approx 1 $\frac{1}{2}$ turns |
| 32SX | approx 3 $\frac{1}{2}$ turns |

SUBSEQUENT STARTING PROCEDURE

Once the optimum needle-valve setting has been established (see page 19, Needle-valve adjustment diagram) the procedure for starting may be simplified as follows.

1. Open the needle-valve one half-turn (180°) from the optimum setting.
2. Set the throttle one-quarter open from the fully closed position, energize the glowplug and apply the electric starter. When the engine starts, re-open the throttle and re-adjust the needle-valve to the optimum setting.

Note:

When re-starting the engine on the same day, provided that atmospheric conditions have not changed significantly, it may be practicable to re-start the engine on its optimum(running) setting.

SUBSEQUENT READJUSTMENT

Once the engine has been run-in and the controls properly set up, it should be unnecessary to alter the mixture settings; except to make minor adjustments to the Needle-Valve occasionally, to take account of variations in climatic conditions.

The use of a different fuel, however, particularly one containing more, or less, nitromethane and/or a different type or proportion of lubricating oil, is likely to call for some readjustment of the Needle-Valve.

Remember that, as a safety measure, it is advisable to increase the Needle-Valve opening by an extra half-turn counter-clockwise, prior to establishing a new setting. The same applies if the silencer type is changed.

A different silencer may alter the exhaust pressure applied to the fuel feed and call for a revised Needle-Valve setting. The use of a different glowplug may also require compensating carburetor readjustments.

CARBURETOR CLEANLINESS

The correct functioning of the carburetor depends on its small fuel orifices remaining clear. The minute particles of foreign matter that are present in any fuel, can easily partially obstruct these orifices and upset mixture strength so that engine performance becomes erratic and unreliable.

O.S.'Super-Filters'(large and small) are available, as optional extras, to deal with this problem.

One of these filters, fitted to the outlet tube inside your refueling container, will prevent the entry of foreign material into the fuel tank.

It is also recommended that a good in-line filter be installed between the tank and needle-valve.

Do not forget to clean the filters regularly to remove dirt and lint that accumulate on the filter screen.

Also, clean the carburetor itself occasionally.

ENGINE CARE AND MAINTENANCE

1. At the end of each operating session, drain out any fuel that may remain in the fuel tank.
2. Next, energize the glowplug and try to restart the engine to burn off any fuel that may remain inside the engine. Repeat this procedure until the engine fails to fire. Remove the glowplug and eject any residue by rotating the engine with an electric starter for 4 to 5 seconds while the engine is still warm.
3. Finally, inject some after-run oil into the engine. Rotate the engine a few times by hand, to make sure that it is free, and then with an electric starter for 4 to 5 seconds to distribute the oil to all the working parts.

Note:

Do not inject after-run oil into the carburetor as this may cause the O-ring inside the carburettor to deteriorate.

These procedures will reduce the risk of starting difficulties and of internal corrosion after a period of storage.

O.S. GENUINE PARTS & ACCESSORIES

■ O.S. GLOW PLUGS

No.8
(71608001)



A3
(71605300)

A5
(71605100)



■ SPINNER NUT



| Code No. | Size | Type of Engine |
|----------|------------|----------------|
| 20824005 | M5 | 15CV-A |
| 23024008 | 1/4"-28 | 20. 25. RE |
| 23024009 | 1/4"-28(L) | 25FX. 32SX |

■ LONG PROPELLER NUT SETS



| Code No. | Size | Type of Engine |
|----------|---------|----------------|
| 73101000 | 1/4"-28 | 25FX. 32SX |

■ SILENCER EXTENSION ADAPTORS

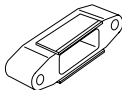

| Code No. | Type of Engine • Silencer |
|----------|---------------------------|
| 21125108 | 15CV-A(871) |
| 22625103 | 25FX(892) |
| 23325100 | 32SX(E-3030) |

■ SILENCER EXHAUST ADAPTORS



| Code No. | Type of Engine • Silencer |
|----------|---------------------------|
| 21125502 | 15CV-A(871) |
| 22625508 | 25FX(892) 32SX(E-3030) |

■ PROPELLER NUT SETS FOR TRUTURN SPINNERS

(73101020)

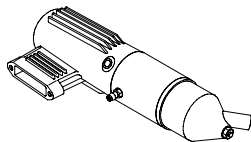

For 25FX.32SX

■ SUPER SILENCERS

| Code No. | Size | Type of Engine |
|----------|---------|----------------|
| 23325030 | E-3030S | 32SX |

■ SUPER FILTER

(72403050)

**■ LOCK WASHER**

(10Sets)

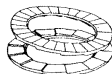

| Code No. | Size | Type of Engine |
|----------|------|----------------|
| 55500002 | M3 | 25FX.32SX |

■ NON-BUBBLE WEIGHT

(71531000)

**■ LONG SOCKET WRENCH WITH PLUG GRIP**

(71521000)

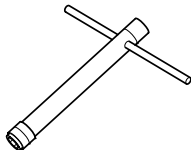

EXPLODED VIEW (15CV-A)

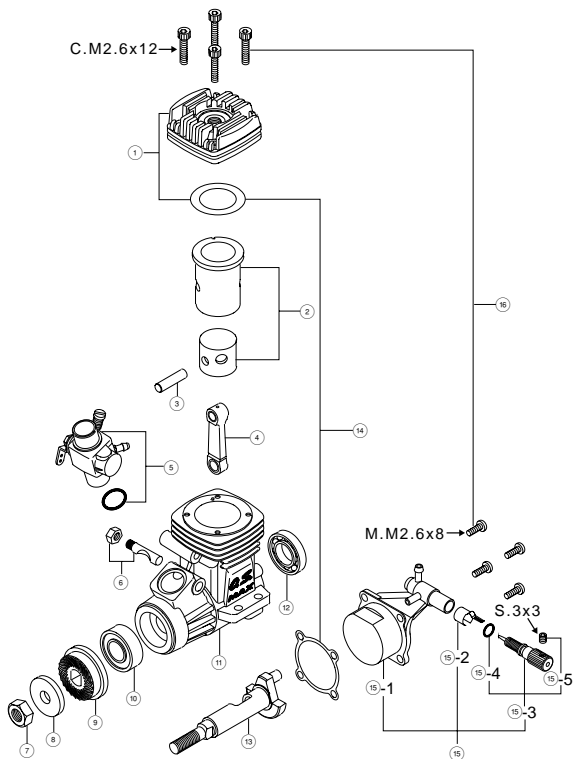

—26—

* Type of screw

C···Cap Screw F···Flat Head Screw N···Round Head Screw S···Set Screw

ENGINEN PARTS LIST (15CV-A)

| No. | Code No. | Description |
|-----|------------|---------------------------------|
| ① | 2 1504 010 | Cylinder Head |
| ② | 2 1503 010 | Cylinder & Piston Assembly |
| ③ | 2 1706 000 | Piston Pin |
| ④ | 2 1205 040 | Connecting Rod |
| ⑤ | 2 1581 000 | Carburetor (Type 10K) |
| ⑥ | 2 1481 700 | Carburetor Retainer |
| ⑦ | 2 0810 007 | Propeller Nut |
| ⑧ | 2 1109 005 | Propeller Washer |
| ⑨ | 2 1408 000 | Drive Hub |
| ⑩ | 2 2631 019 | Crankshaft Ball Bearing (Front) |
| ⑪ | 2 1501 020 | Crankcase |
| ⑫ | 2 1230 000 | Crankshaft Ball Bearing (Rear) |
| ⑬ | 2 1502 000 | Crankshaft |
| ⑭ | 2 1514 010 | Gasket Set |
| ⑮ | 2 1507 000 | Cover Plate Assembly |
| ⑮-1 | 2 1507 100 | Cover Plate Body |
| ⑮-2 | 2 6711 305 | Ratchet Spring |
| ⑮-3 | 2 1781 970 | Needle |
| ⑮-4 | 2 4981 837 | "O"Ring For Needle (2pcs.) |
| ⑮-5 | 2 6381 501 | Set Screw |
| ⑯ | 2 1513 000 | Screw Set |
| | 7 1605 300 | Glow Plug A3 |
| | 2 1225 000 | 871 Silencer |
| | 2 2681 957 | Exhaust Pressure Nipple |
| | 2 2325 300 | Assembly Screw |
| | 2 1225 500 | Retaining Screw (2pcs.) |

Specifications are subject to alteration for improvement without notice.

EXPLODED VIEW (25FX,32SX)

—28—

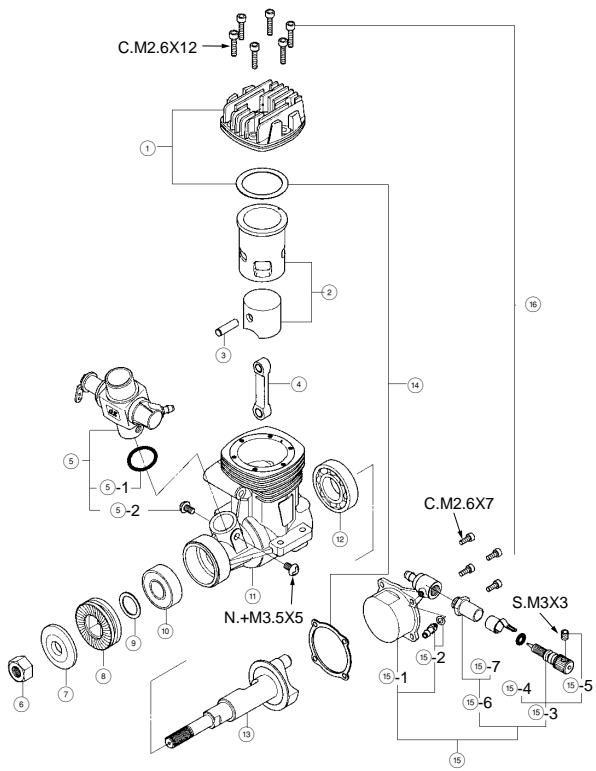

* Type of screw

C···Cap Screw F···Flat Head Screw N···Round Head Screw S···Set Screw

ENGINEN PARTS LIST (25FX,32SX)

| No. | Description | Code No. | |
|-----|------------------------------------|----------|----------|
| | | 25FX | 32SX |
| ① | Cylinder Head | 22604020 | 23404100 |
| ② | Cylinder & Piston Assembly | 22603040 | 23403000 |
| ③ | Piston Pin | 22606009 | 23406000 |
| ④ | Connecting Rod | 22805010 | 23405000 |
| ⑤ | Carburetor (Type 20D) | 22681030 | — |
| ∕ | Carburetor (Type 20F) | — | 23482000 |
| ⑤-1 | Carburetor Rubber Gasket | 22615000 | 22615000 |
| ⑤-2 | Carburetor Retaining Screw (2pcs.) | 23081706 | 23081706 |
| ⑥ | Propeller Nut (UNF1/4-28) | 23210007 | 23210007 |
| ⑦ | Propeller Washer | 23009006 | 23009006 |
| ⑧ | Drive Hub | 22808000 | 22808000 |
| ⑨ | Thrust Washer | 22620003 | 22620003 |
| ⑩ | Crankshaft Ball Bearing (Front) | 22831000 | 22831000 |
| ⑪ | Crankcase | 22601050 | 23401000 |
| ⑫ | Crankshaft Ball Bearing (Rear) | 22630002 | 23430000 |
| ⑬ | Crankshaft | 22602030 | 23402100 |
| ⑭ | Gasket Set | 22614010 | 23414000 |
| ⑮ | Cover Plate Assembly | 22607010 | 23407000 |
| ⑮-1 | Cover Plate Body | 22607011 | 23407100 |
| ⑮-2 | Nipple No.1 | 22681953 | 22681953 |
| ⑮-3 | Needle | 22681980 | 22681980 |
| ⑮-4 | "O"Ring For Needle (2pcs.) | 24981837 | 24981837 |
| ⑮-5 | Set Screw | 26381501 | 26381501 |
| ⑮-6 | Needle Valve Holder Assembly | 27381940 | 27381940 |
| ⑮-7 | Ratchet Spring | 26711305 | 26711305 |
| ⑯ | Screw Set | 22413009 | 22413009 |
| | 892 Silencer (For 25FX) | 22628000 | — |
| | E-3030 Silencer (For 32SX) | — | 23325020 |
| | Exhaust Pressure Nipple | 22681957 | 22681957 |
| | Assembly Screw | 23325300 | 23325320 |
| | Retaining Screw (2pcs.) | 22625404 | 22625404 |

Specifications are subject to alteration for improvement without notice.

CARBURETOR 10K (15CV-A)

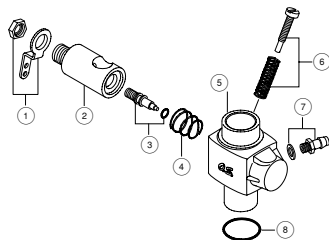

* Type of screw

C...Cap Screw F...Flat Head Screw
N...Round Head Screw S...Set Screw

| No. | Code No. | Description |
|-----|------------|----------------------------------|
| ① | 2 2681 430 | Throttle Lever Assembly |
| ② | 2 1284 200 | Carburettor Rotor |
| ③ | 2 1284 600 | Mixture Control Screw (W/O-Ring) |
| ④ | 2 2481 506 | Rotor Spring |
| ⑤ | 2 1581 100 | Carburettor Body |
| ⑥ | 2 2681 320 | Throttle Stop Screw |
| ⑦ | 2 2681 953 | Fuel Inlet (W/Washer) |
| ⑧ | 2 2615 000 | Carburetor Rubber Gasket |

Specifications are subject to alteration for improvement without notice.

CARBURETOR 20D (25FX)

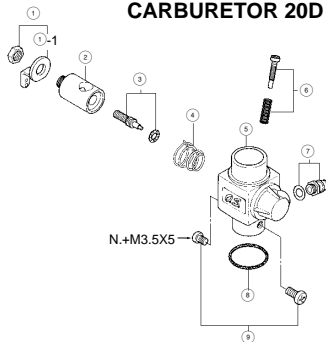

| No. | Code No. | Description |
|-----|----------|----------------------------------|
| ① | 22681430 | Throttle Lever Assembly |
| ①-1 | 22681419 | Throttle Lever |
| ② | 22681220 | Carburettor Rotor |
| ③ | 22681600 | Mixture Control Screw (W/O-Ring) |
| ④ | 22481506 | Rotor Spring |
| ⑤ | 22681140 | Carburettor Body |
| ⑥ | 22681320 | Throttle Stop Screw |
| ⑦ | 22681953 | Fuel Inlet (W/Washer) |
| ⑧ | 22615000 | Carburetor Rubber Gasket |
| ⑨ | 23081706 | Carburettor Retaining Screw |

CARBURETOR 20F (32SX)

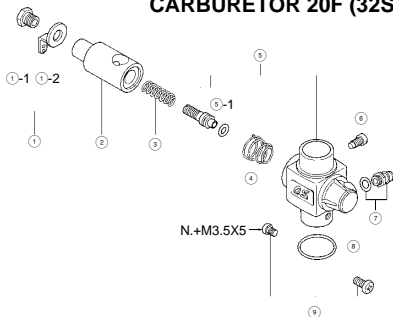

| No. | Code No. | Description |
|-----|----------|------------------------------|
| ① | 22781401 | Throttle Lever Assembly |
| ①-1 | 22781420 | Throttle Lever Fixing Screw |
| ①-2 | 22781411 | Throttle Lever |
| ② | 23481200 | Throttle Rotor |
| ③ | 23481650 | Mixture Control Valve Spring |
| ④ | 26781506 | Rotor Spring |
| ⑤ | 23482100 | Carburettor Body |
| ⑤-1 | 24881824 | "O" Ring (2pcs.) |
| ⑥ | 45581820 | Rotor Guide Screw |
| ⑦ | 22681953 | Fuel Inlet (W/Washer) |
| ⑧ | 22615000 | Carburetor Rubber Gasket |
| ⑨ | 23081706 | Carburetor Retaining Screw |

THREE VIEW DRAWING

MAX-15CV-A SPECIFICATIONS

| | |
|--------------------|-------------------------|
| ■ Displacement | 2.49 cc (0.152 cu.in.) |
| ■ Bore | 15.2mm (0.598 in.) |
| ■ Stroke | 13.7mm (0.539 in.) |
| ■ Practical R.P.M. | 2,500~19,000 r.p.m. |
| ■ Power output | 0.5 bhp / 18,000 r.p.m. |
| ■ Weight | 170g (5.99 oz.) |

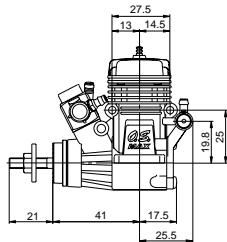
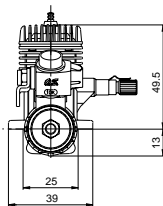
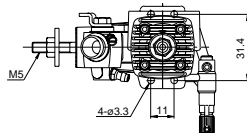

THREE VIEW DRAWING MAX-25FX

SPECIFICATIONS

| | |
|--------------------|--------------------------|
| ■ Displacement | 4.07 cc (0.2485 cu.in.) |
| ■ Bore | 18.0mm (0.7087 in.) |
| ■ Stroke | 16.0mm (0.630 in.) |
| ■ Practical R.P.M. | 2,500~19,000 r.p.m. |
| ■ Power output | 0.84 bhp / 18,000 r.p.m. |
| ■ Weight | 248g (8.75 oz.) |

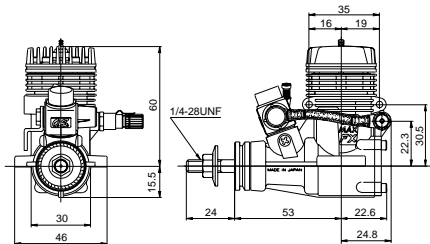
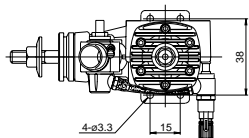

SPECIFICATIONS

MAX-32SX

| | |
|--------------------|-------------------------|
| ■ Displacement | 5.23 cc (0.319 cu.in.) |
| ■ Bore | 19.5mm (0.768 in.) |
| ■ Stroke | 17.5mm (0.689 in.) |
| ■ Practical R.P.M. | 2,000~22,000 r.p.m. |
| ■ Power output | 1.2 bhp / 18,000 r.p.m. |
| ■ Weight | 270g (9.5 oz.) |

Dimensions(mm)

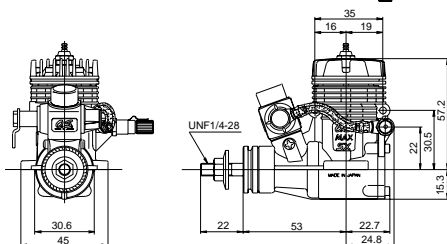
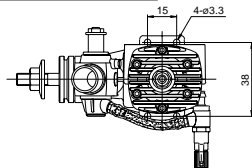



O.S. ENGINES MFG.CO.,LTD.

6-15 3-Chome Imagawa Higashisumiyoshi-ku
Osaka 546-0003, Japan TEL. (06) 6702-0225

FAX. (06) 6704-2722

URL : <http://www.os-engines.co.jp>

© Copyright 2000 by O.S.Engines Mfg. Co., Ltd. All rights reserved. Printed in Japan.