

---

# ***O.S. ENGINE*** MAX-21RG-M & MAX-21RG-MX

---

## **OWNER'S INSTRUCTION MANUAL**

It is of vital importance, before attempting to operate your engine, to read the general **'SAFETY INSTRUCTIONS AND WARNINGS'** section on pages 2-5 of this booklet and to strictly adhere to the advice contained therein.

- Also, please study the entire contents of this instruction manual, so as to familiarize yourself with the controls and other features of the engine.
- Keep these instructions in a safe place so that you may readily refer to them whenever necessary.
- It is suggested that any instructions supplied with the vehicle, radio control equipment, etc., are accessible for checking at the same time.

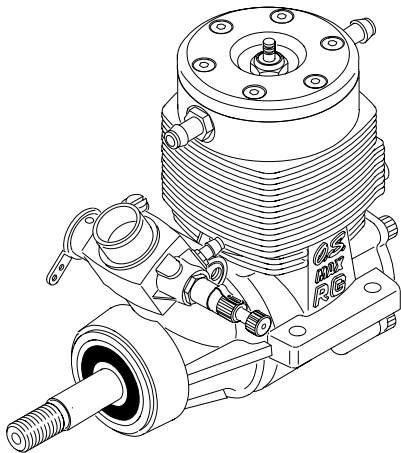

## CONTENTS

SAFETY INSTRUCTIONS AND WARNINGS ABOUT YOUR O.S. ENGINE .....	2~5	CARE AND MAINTENANCE .....	18~19
INTRODUCTION, BASIC ENGINE PARTS .....	6	CHECKING OF THE ENGINE .....	19
INSTALLATION .....	7~8	TROUBLE SHOOTING WHEN THE ENGINE FAILS TO START .....	20~21
NOTES CONCERNING THE RECOIL STARTER .....	8~9	ENGINE EXPLODED VIEW .....	22
GLOWPLUG .....	9~10	ENGINE PARTS LIST .....	23
TOOLS, ACCESSORIES, etc. ....	10~11	CARBURETTOR EXPLODED VIEW & PARTS LIST .....	24
CARBURETTOR CONTROLS .....	12	O.S. GENUINE PARTS & ACCESSORIES .....	25
STARTING & INITIAL RUNNING-IN('Breaking-in) .....	13~15	THREE VIEW DRAWING .....	26~27
ADJUSTMENT .....	16~17	MEMO .....	28

## **SAFETY INSTRUCTIONS AND WARNINGS ABOUT YOUR O.S. ENGINE**

Remember that your engine is not a "toy", but a highly efficient internal-combustion machine whose power is capable of harming you, or others, if it is misused.

As owner, you, alone, are responsible for the safe operation of your engine, so act with discretion and care at all times.

If at some future date, your O.S. engine is acquired by another person, we would respectfully request that these instructions are also passed on to its new owner.

- The advice which follows applies basically to **ALL MODEL ENGINES** and is grouped under two headings according to the degree of damage or danger which might arise through misuse or neglect.



### **WARNINGS**

These cover events which might involve serious (in extreme circumstances, even fatal) injury.



### **NOTES**

These cover the many other possibilities, generally less obvious sources of danger, but which, under certain circumstances, may also cause damage or injury.



## WARNINGS

- Never touch, or allow any object to come into contact with, the rotating propeller and do not crouch over the engine when it is running.
- Model engine fuel is poisonous. Do not allow it to come into contact with the eyes or mouth. Always store it in a clearly marked container and out of the reach of children.
- Model engine fuel is also highly flammable. Keep it away from open flame, excessive heat, sources of sparks, or anything else which might ignite it. Do not smoke or allow anyone else to smoke, near to it.



- Never operate your engine in an enclosed space. Model engines, like automobile engines, exhaust deadly carbon-monoxide. Run your engine only in an open area.
- Model engines generate considerable heat. Do not touch any part of your engine until it has cooled. Contact with the muffler (silencer), cylinder head or exhaust header pipe, in particular, may result in a serious burn.





## NOTES

- This engine was designed for model boats. Do not attempt to use it for any other purpose.
- Mount the engine in your model securely, following the manufacturers' recommendations, using appropriate screws and lock-nuts.
- Fit an effective silencer (muffler). Frequent close exposure to a noisy exhaust (especially in the case of the most powerful high-speed engines) may eventually impair your hearing and such noise is also likely to cause annoyance to others over a wide area.
- For their safety, keep all onlookers (especially small children) well back (at least 20 feet or 6 meters) when preparing your model for running.
- Take care that the glowplug clip or battery leads do not come into contact with the propeller or any other rotating parts. Also check that the linkage to the throttle arm is secure.
- If your engine does not have a built-in recoil starter, use an electric starter. The wearing of safety glasses is also strongly recommended.
- When handling the boat immediately prior to launching, be especially cautious. Keep the propeller and other rotating parts away from you.



## NOTES

- Adjust the throttle linkage so that the engine stops when the throttle stick and trim lever on the transmitter are fully retarded. Alternatively, the engine may be stopped by cutting off the fuel supply. Never try to stop the engine physically.
- Warning! Immediately after a glowplug-ignition engine has been run and is still warm, conditions sometimes exist whereby it is just possible for the engine to abruptly restart if it is rotated over compression WITHOUT the glowplug battery being reconnected.
- If your engine is fitted with a recoil starter, pull the operating handle straight out when starting the engine, so that the cord does not rub against the hull or engine. This will help prevent the cord from being damaged by abrasion or engine heat.
- Do not extend the starter cord more than 45cm (18"). Do not abruptly release the operating handle. Allow the cord to rewind smoothly while still holding the handle.
- Do not attempt to disassemble the recoil starter (if fitted). If you do so, the very strong spring inside will be suddenly ejected. This can be very dangerous.

The O.S. "RG Series" is a high-performance water-cooled marine engine for small radio-controlled boats, especially sport type hulls. A companion model, the MAX-21RG-MX incorporating a recoil starter system is also available.

#### Standard accessories

- Glow Plug No.8
- Exhaust Header Pipe
- Flywheel No2E

### NOTE

- With this engine, the piston will feel tight at the top of its stroke when the engine is cold. This is normal. The piston and cylinder are designed to achieve a perfect running clearance when they reach their normal running temperatures.
- We do not recommend running your boat on the sea, or in any other saltwater environment. Under such conditions, it is difficult to prevent the engine from becoming corroded and, eventually, inoperative.

## BASIC ENGINE PARTS MAX-21RG-MX

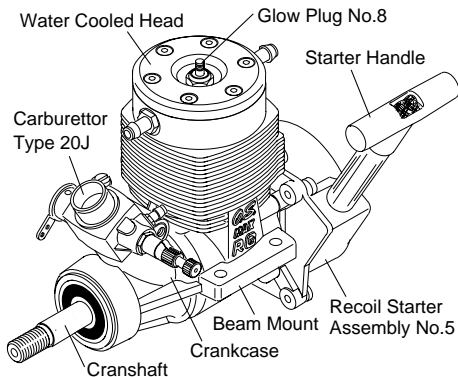

### INSTALLING THE GLOWPLUG

Install the washer on the glowplug and insert carefully into cylinder-head, making sure that it is not cross-threaded before tightening firmly.

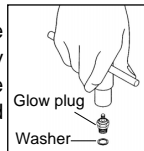

## INSTALLATION OF THE CARBURETOR

As delivered, the engine has its carburetor lightly fitted into its intake boss. Secure it as follows.

1. Loosen the retainer screw, rotate the carburetor to its correct position and make sure that it is pressed well down into the intake boss, compressing the rubber gasket, before retightening screw.
2. Rotate the retainer screw gently until it stops, then tighten a further 90-120°. Do not overtighten the screw as this will damage the carburetor body.

Rotate the retainer nut gently until it stops.

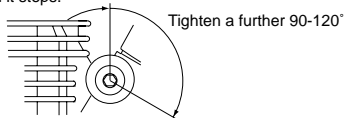

## INSTALLATION OF THE FLYWHEEL

Insert the taper collet on the crankshaft, taking care not to push the crankshaft to the cover plate end.

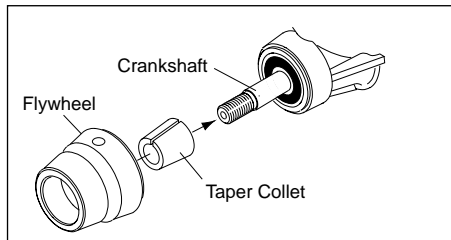

## INSTALLATION OF THE EXHAUST HEADER PIPE

Select the screw holes according to the model.

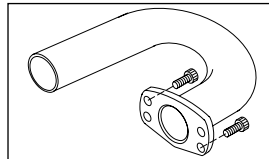



---

## INSTALLATION

1. Make sure that the engine mounting beams in the hull are parallel, with their top surfaces in the same plane. If they are not, the engine will not rest firmly as the engine mounting faces (undersides of the mounting lugs) are precision machined to be flat and in the same plane. Poor installation may not only cause vibration, erratic running and loss of performance, but may also damage the engine itself by deforming the crankcase, cylinder, etc.
2. The mounting beams and adjacent hull structure should be as rigid as possible so that the engine may develop its full performance. Use 3mm steel screws, such as Allen socket-head type, with locknuts, for bolting the engine to the mounting beams.
3. If the holes in the mounting beams do not align exactly with the engine's mounting lugs, enlarge them slightly with a needle file so that the mounting screws pass through the holes smoothly without being forced.

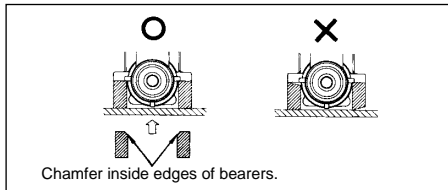

---

## NOTES CONCERNING THE RECOIL STARTER REMINDER!

- ◆ Do not attempt to disassemble the recoil starter. If you do so, the very strong spring inside will be suddenly ejected. This can be very dangerous.
- ◆ Do not extend the starter cord more than 45cm(18"). Do not abruptly release the operating handle. Allow the cord to rewind smoothly while still holding the handle.
- ◆ Pull the operating handle straight out when starting the engine, so that the cord does not rub against the vehicle body or engine. This will help prevent the cord from being damaged by abrasion or engine heat.

- ◆ Try to avoid spilling fuel over the starter unit and its cord. Some fuels have a detrimental effect on these parts.
- ◆ The starter prevents the engine from being rotated in the wrong direction. The unit will be damaged if you attempt to force the flywheel in the opposite direction (i.e. clockwise when viewed from the crankshaft end).

**NOTE:** Because, in the interests of personal safety, dismantling of the starter mechanism is strongly discouraged, the Recoil Starter is available for replacement only as a pre-assembled unit. However, some related parts, such as Starting Shaft and Rear Adaptor, are obtainable separately. (See Parts List.)

---

## GLOWPLUG

Since the compatibility of the glowplug and fuel can have a marked effect on performance and reliability, it is suggested that the user selects the R/C type plug found most suitable after practical experiments. Generally, for a fuel containing about 30% nitromethane, a medium heat range glowplug will be suitable.

For higher nitro fuel, a cold rated plug may be required, whereas, for lower nitro fuel, a hot rated plug may be best. However, the O.S. No.8 glowplug may be employed irrespective of the nitro content of the fuel.

### The role of the glowplug

With a glowplug engine, ignition is initiated by the application of a 1.5-volt power source. When the battery is disconnected, the heat retained within the combustion chamber remains sufficient to keep the plug filament glowing, thereby continuing to keep the engine running. Ignition timing is 'automatic': under reduced load, allowing higher rpm, the plug becomes hotter and, appropriately, fires the fuel/air charge earlier; conversely, at reduced rpm, the plug becomes cooler and ignition is retarded.

## Glowplug life

Particularly in the case of very high performance engines, glowplugs must be regarded as expendable items. However, plug life can be extended and engine performance maintained by careful use, i.e.:

- Install a plug suitable for the engine.
- Use fuel containing a moderate percentage of nitromethane unless more is essential for racing events.
- Do not run the engine too lean and do not leave the battery connected while adjusting needle.

## When to replace the glowplug

Apart from when actually burned out, a plug may need to be replaced because it no longer delivers its best performance, such as when:

- Filament surface has roughened and turned white.
- Filament coil has become distorted.
- Engine tends to cut out when idling.
- Starting qualities deteriorate.
- Foreign matter has adhered to filament or plug body has corroded.

---

## TOOLS, ACCESSORIES, etc.

The following items are necessary for operating the engine.

### FUEL

When the brand of fuel is changed, or the nitro content increased, it is advisable to repeat the running-in procedure referred to in the RUNNING-IN paragraphs. For consistent performance and long engine life, it is essential to use a good quality fuel containing NOT LESS THAN 18% lubricant. Please note that with high-nitro fuels, although power may be increased for competition purposes, glowplug elements do not last as long and engine life will be shortened.

### REMINDER!

**Model engine fuel is poisonous. Do not allow it to come into contact with the eyes or mouth.**  
 **Always store it in a clearly marked container and out of the reach of children.**

**Model engine fuel is also highly flammable. Keep it away from open flame, excessive heat, sources of sparks, or anything else which might ignite it. Do not smoke or allow anyone else to smoke, near to it.**  

## PROPELLER

Use well balanced propellers only. As the ideal diameter, pitch and shape vary according to the size, weight and type of model, final selection can be made after practical experiment. As a starting point, suggested propeller diameter is 40-44mm with a pitch/dia ratio of 1.0-1.6 for Vee type hulls.

## REMINDER!



**Never touch, or allow any object to come into contact with, the rotating propeller and do not crouch over the engine when it is running.**

## BATTERY INTEGRATED GLOWPLUG HEATER

Commercially available handy glowplug heater in which the glowplug battery and battery leads are integrated.

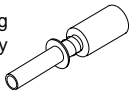

## ELECTRIC STARTER AND STARTER BATTERY

Use a 12-volt electric starter with suitable battery for starting the engine.(21RG-M)

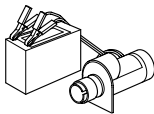

## FUEL PUMP

For filling the fuel tank, a simple, polyethylene "squeeze" bottle, with a suitable spout, is required.



## LONG SOCKET WRENCH

Recommended for easy removal and replacement of the angled and recessed glowplug, the O.S.Long Socket Wrench incorporates a special grip.

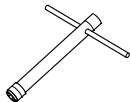

## SILICONE FUEL LINE

This is required for the connection between the fuel tank and engine, also for the water-cooling system.

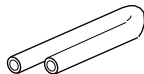

## CARBURETTOR CONTROLS

Two adjustable controls are provided on this carburettor.

### ● The Needle Valve:

When set to produce maximum power at full throttle, this establishes the basic fuel/air mixture strength. This is then maintained by the carburettor's automatic mixture control system to cover the engine's requirements at reduced throttle settings.

### ● The Mixture Control Valve (Mixture Control Screw):

For adjusting the mixture strength at part-throttle and idling speeds, to obtain steady idling and smooth acceleration to medium speeds. The Mixture Control Valve has been factory set for the approximate best result. First, run the engine as received, and re-adjust the Mixture Control Valve only when necessary.

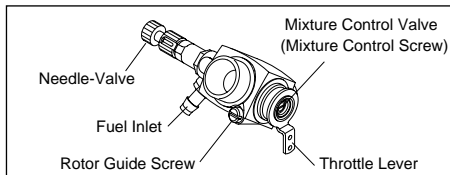

### ■ REALIGNMENT OF MIXTURE CONTROL VALVE

In the course of making carburettor adjustments, it is just possible that the Mixture Control Valve may be inadvertently screwed in or out too far and thereby moved beyond its effective adjustment range.

Its basic setting can be reestablished as follows :

The basic ( factory ) setting is as shown in the main sketch, i. e. with the shoulder portion 'A' exactly at a tangent to the throttle rotor hole. To return the Mixture Control Valve to its original position, first screw in the Mixture Control Valve, while looking into the rotor hole.

Then gradually unscrew the Mixture Control Valve until 'A' is precisely tangential to the rotor hole (i.e. so that 'A' and 'B' are superimposed) as in the main sketch.

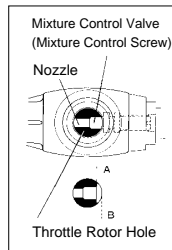

## STARTING & INITIAL RUNNING-IN('Breaking-in')

When starting the engine, put the hull on a stand, etc. out of the water.

For long life and high performance, every engine needs to be 'run-in' or 'broken-in'. With care, running-in of the engine can be carried out with it installed in the boat. Be sure to use a muffler-pressurized fuel system.

■ In case of the 21RG-M

- ◆ Set the needle-valve. Turn the needle clockwise slowly, without forcing, until it stops. Then, reopen the needle-valve 2-1/2turns counterclockwise.

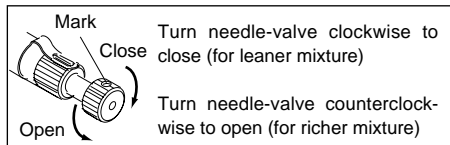

◆ Priming

- Open the throttle fully and place your finger over the carburetor to choke intake.

- Turn the flywheel by hand to draw the fuel to the fuel inlet.
- Turn the flywheel two more revolutions to draw the fuel inside the engine.

### NOTE (IMPORTANT)

The quantity of fuel drawn into the engine by priming is an important factor in starting the engine successfully. When the engine is being started for the first time, turn the flywheel two revolutions after fuel reaches the fuel inlet, as described above. However, when re-starting the engine immediately after a run, one revolution, or even no priming at all may be required. The engine's requirements will be quickly learned with experience.

- ◆ Open the throttle very slightly:

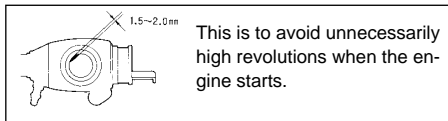

- ◆ Heat the glowplug by connecting the battery leads. Make sure that the direction of rotation of the electric starter is correct, namely, clockwise.
- ◆ If necessary, reverse leads on battery to provide clockwise rotation.
- ◆ Hang the starter belt over the flywheel and starter and depress the starter switch for one or two seconds. Repeat if necessary. When the engine fires, withdraw the starter immediately.

**Warning:**

**Do not apply the starter to a flooded engine and never place your finger over the carburettor intake when using the starter. This may cause an hydraulic lock and bend the connecting-rod.**

■ In case of the 21RG-MX

- Take the same procedure as the 21RG-M to the point of "Heat the glowplug by connecting the battery leads".
- Pull the starter handle briskly straight out several times to start the engine.

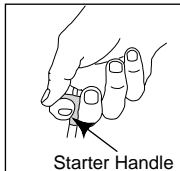

- ◆ To stop the engine, fully close the throttle to cut off air supply.

**PRECAUTIONS**

**When starting the engine, the hull is off the water and the engine is run with no load, and with even below half throttle engine r.p.m. come high. Prolonged running with this condition may result in the seizure of the connecting rod and crank pin. Never run the engine with high r.p.m. (never open the throttle beyond the starting setting) with no load (i.e. the hull is off the water).**

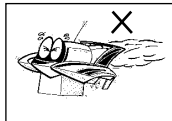

Warm up the engine by running it at around idling setting for a while after starting,

- ◆ As with the engine of a full size boat. High r.p.m. operation without warming up will shorten engine life or damage it.
- ◆ Leaving the Needle-Valve set at the starting setting of 2-1/2 turns open, run the boat several times with the throttle fully open until at least three full tanks of fuel have been consumed. (It should be noted, at this stage, it may not be possible for the engine to idle reliably because of the over-rich setting of the Needle-Valve.)
- ◆ This completes the initial running-in stage. For the remaining period of running-in, refer to the adjustment procedures detailed later. The boat will need to be run for about 10 tanks of fuel to complete the running-in period.

**Note!**

**If as a result of your boat being capsized, the engine takes in water, remove the glowplug, invert the engine and eject water by carefully turning the flywheel, first by hand and then with the electric starter. Make every effort to ensure that no water remains in the engine before attempting to restart it, or it may be damaged by an hydraulic lock.**

**To ensure that any traces of water (which may also cause internal rusting if not dealt with) are flushed out, use an appropriate water-displacing spray lubricant.**



## ADJUSTMENT

### WARNING :

Running the engine with the boat out of the water, without load and without cooling water, will seriously damage it, due to overheating. Therefore, always lower the boat into the water immediately after the engine has been started, so as to prevent over-speeding and to allow cooling water to be forced up to the cylinder-head. Having carried out the initial running-in ("breaking-in") procedure as described before, complete the running-in as follows:

1. Open the throttle slightly from the idling position and start the engine, following the procedure described previously.

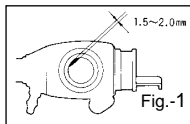

2. Lower the boat into the water, gradually open the throttle and run the boat straight ahead for 20 to 30 metres at full throttle. Now return the model and close the needle-valve 20 to 30°. Repeat the run, taking note of the improvement in speed.

3. Continue with further runs, gradually closing the needle-valve (20 to 30° at a time) until no further increase in speed is obtained.
4. If the needle-valve is closed beyond the optimum setting, the model will slow down, accompanied by visibly diminished exhaust smoke. In this case, immediately throttle down and return the model to shore. Re-open the needle-valve approximately one-half turn and repeat the runs until the optimum needle setting is found.
5. Aim to have the model achieving its highest performance after the engine has consumed about one liter of fuel. Having found the optimum needle-valve setting, make a note of the number of turns necessary to quart this from the closed position.
6. With the engine run-in and the optimum needle-valve setting determined, the mixture control valve should be checked as follows:

7. Launch the boat and gradually open the throttle to its fullest extent. If at this point, the engine puffs out a good deal of smoke and does not accelerate smoothly and rapidly, it is a sign that the idling mixture is too rich. Therefore, turn the mixture control screw clockwise 45 to 60°. Repeat the run and recheck the result.
8. If, on the other hand, the idling mixture is too lean, the engine is likely to speed up momentarily, then cut out abruptly when the throttle is re-opened. In this case, first turn the mixture control screw counter-clockwise 90° to make sure that the mixture has become richer, then make incremental adjustments, each way, until an acceptable balance between rich v.lean settings is achieved. Carry out these adjustments patiently under actual running conditions, until the engine responds quickly and positively to throttle movements. Use a small screwdriver to adjust the mixture control valve via its slotted screwhead in the center of the outer end of the throttle rotor.
9. With the optimum mixture control valve position, light smoke is visible during high-speed running and engine r.p.m. increase smoothly during acceleration.
10. Remember that, if the engine is operated with the fuel/air mixture slightly too lean, it will overheat and run unevenly or cut out. As with all engines, it is wise to set both valves a little on the rich side of the best rpm setting, as a safety measure. When the best balance of mixture adjustments has been determined and, especially as the engine becomes fully run-in, it will probably be found that the idling speed has increased. Readjust the throttle opening by means of the trim lever on the transmitter, so that the lowest idling speed, without risk of stalling the engine, may be obtained.

**WARNING :**

**For safety reasons, it is advisable to stop the engine before carrying out adjustments to the Mixture Control Screw.**

**Note :**

**Once the correct carburettor settings have been established, it should be unnecessary to alter them. Such slight Needle-Valve readjustments as may be required to compensate for variations in atmospheric conditions will not normally affect the other two controls. Slight readjustments may be necessary for optimum performance if different types of fuel, glowplugs or propellers are used.**

## CARBURETTOR CLEANLINESS

Proper functioning of the carburettor depends on its small fuel orifices remaining clear. The minute particles of foreign matter that are present in any fuel, can partially obstruct these orifices and upset mixture strength so that engine performance becomes erratic and unreliable. It is recommended that fuel is passed through a filter when the tank is filled and that a good in-line filter is installed between the fuel tank and carburettor and, furthermore, that this filter is frequently cleaned to remove dirt and lint that accumulate on the filter screen. Finally, occasionally remove the needle-valve holder from the carburettor as shown below and extract any remaining foreign matter that may have lodged in the location shown.

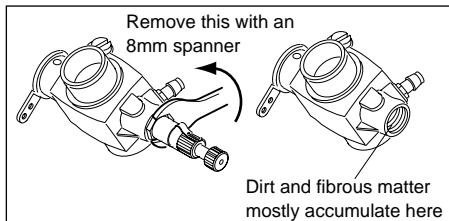

## CARE AND MAINTENANCE

To ensure that you obtain long life and peak performance from your engine, observe the following.

- ① As previously observed, foreign matter in the fuel can cause problems. Therefore:
  - rinse out the fuel tank with methanol or fuel before installing it.
  - Install a fuel filter to the fuel delivery tube between tank and carburettor.
  - Install a fuel filter to the outlet of your squeeze bottle, or to the pump inlet if you use a manual or electric pump. \*
  - do not leave your fuel container open needlessly.

\* O.S. 'Super-Filter' (L) is available, as optional extra, to deal with this problem. To fit this filter to the outlet tube inside your refuelling container, will prevent the entry of foreign material into the fuel tank.
- ② Do not forget to clean the filters regularly to remove dirt and lint that accumulate on the filter screens. Also, clean the carburettor itself occasionally.

- ③ At the end of each operating session, drain out any fuel that may remain in the fuel tank. Afterwards, energize the glowplug and try to restart the engine, to burn off any fuel that may remain inside the engine. Repeat this procedure until the engine fails to fire. Leaving fuel residues within the engine can result in difficult starting after a period of storage. It may also cause corrosion. To reduce such risks, it is helpful to inject some corrosion inhibiting oil into the engine's air intake. Rotate the engine many times to distribute the oil to all the working parts.
- ④ Drain the water remaining in the water cooling head, and wash out with methanol, then inject corrosion-inhibiting or moisture-displacing oil.
- ⑤ When cleaning the exterior of the engine, use methanol or kerosene. Do not use gasoline or any solvent that might damage the silicone fuel tubing or any plastic parts of the boat hull.
- ⑥ When the engine is not in use remove the glow-plug and rinse out the interior with kerosene (not gasoline), by rotating the crankshaft. Shake out residue, then inject light machine-oil through the plug hole again rotating the shaft to distribute the protective oil to all working parts.

- ⑦ In the event of water having entered the cylinder, crankcase, etc., refer to the procedures recommended in the footnote to "running-in" section.
- ⑧ Avoid unnecessary disassembly of your engine.

---

## CHECKING OF THE ENGINE

After a long use, the engine will not develop the standard performance due to wear of parts. It is suggested to replace the parts, such as ball bearings, connecting rod, cylinder & piston assembly and crankcase, as necessary after checking when the following symptoms are found.

- Idling gets unstable and/or the engine stops at idling.
- Engine sound changes and the engine tends to overheat.
- Power drops extremely.

## TROUBLE SHOOTING WHEN THE ENGINE FAILS TO START

### Four key points

For quick, reliable starting, the following four conditions are required.

- ① **Good compression.**    ② **Adequate "glow" at glowplug.**    ③ **Correct mixture.**  
 ④ **Sufficient electric starter rotating speed.**

If the engine fails to start, or does not keep running after being started, check symptoms against the following chart and take necessary corrective action.

**Note:** The most common causes of trouble are marked with three asterisks, the less common problems with one or two asterisks.

Symptom	Factor	Cause	Corrective action
Engine fails to fire.	④	★ Sluggish rotation .....	Recharge the electric starter battery. Pull the recoil starter briskly.
		★★ Glowplug battery .....	Recharge lead-acid cell or replace dry battery. (Note: An unused, or almost unused, dry battery may sometimes be of insufficient capacity if it is "old stock".)
	②	★ Glowplug element .....	Replace glowplug. Check that applied voltage is not too high.
		★ Something wrong .....	Check glowplug heating using other leads.
	③	★★ Engine "flooded" .....	Close needle-valve fully and remove glowplug, Apply starter to pump out excess fuel. Re-start engine.
		★ Insufficient fuel. ....	Refer to p.9

Symptom	Factor	Cause	Corrective action
Engine fires intermittently but does not run.	②—★★	Incorrect heating of glowplug.	Voltage too high or too low. Re-check and readjust referring to "BEFORE STARTING"
	③—★★	Excess fuel	Continue to apply starter. If necessary disconnect battery from glowplug and leave for a few minutes, then re-energize plug. If engine still does not start, remove glowplug and pump out excess fuel. Then re-start.
	④—★	Sluggish rotation.	Recharge the electric starter battery.
Engine fires once or twice, then fails to fire.	②—★★	Glowplug battery discharged.	Recharge lead-acid cell or replace dry battery. (Note: An unused, or almost unused, dry battery may sometimes be of insufficient capacity if it is "old stock".)
Engine starts but revolutions decrease and engine eventually stops.	③—★★	Insufficient fuel	Refer to p.9
	③—★★★	Mixture too rich.	Close needle-valve half turn (180°) and wait for several minutes, then re-start.
Engine starts, then revolutions increase and engine cuts out.	③—★	Fuel not reaching the engine.	Make sure that tank is filled with fuel. Check that there is not something wrong with fuel tubing (kinked or split). Check that carburettor is not clogged with dirt.
Engine stops when battery leads are disconnected after starting.	③—★★	Mixture too rich.	Close the needle-valve a little.
	②—★	Mismatch of glow plug and fuel.	Change fuel or glowplug.

# MAX-21RG-M/MX EXPLODED VIEW

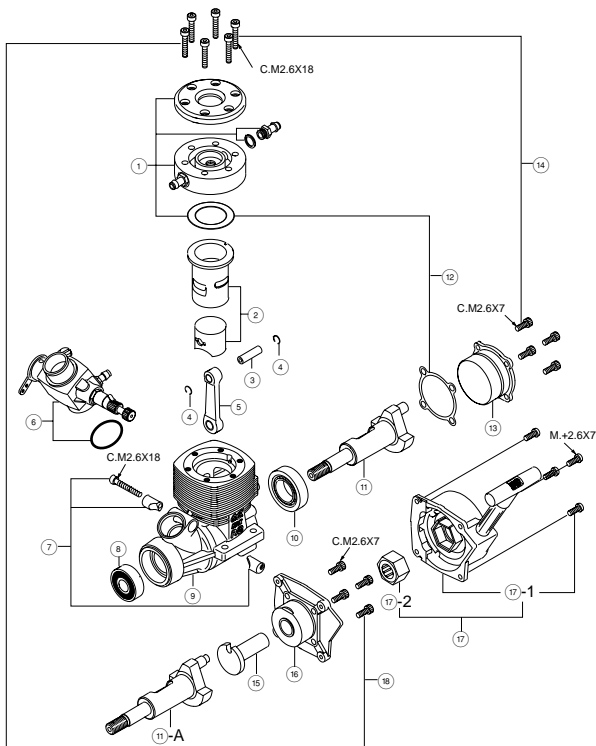

\* Type of screw C...Cap Screw M...Oval Fillister-Head Screw  
 F...Flat Head Screw N...Round Head Screw S...Set Screw

## MAX-21RG-M/MX ENGINE PARTS LIST

No.	Code No.	Description
①	2 3704 100	Water Cooled Head Assembly
②	2 3603 000	Cylinder & Piston Assembly
③	2 3906 000	Piston Pin
④	2 3817 000	Piston Pin Retainer(2pcs.)
⑤	2 3605 000	Connecting Rod
⑥	2 5382 000	Carburetor Complete (Type 20J)
⑦	2 3981 700	Carburetor Retainer
⑧	4 1614 000	Crankshaft Ball Bearing (Front)
⑨	2 3601 000	Crankcase
⑩	2 3430 000	Crankshaft Ball Bearing (Rear)
⑪	2 3602 000	Crankshaft 【For RG-M】
⑪-A	2 3602 030	Crankshaft 【For RG-MX】
⑫	2 3614 000	Gasket Set
⑬	2 3607 000	Cover Plate
⑭	2 3813 001	Screw Set 【For RG-M】
⑮	2 3602 050	Starting Shaft 【For RG-MX】
⑯	2 3601 800	Rear Adaptor 【For RG-MX】
⑰	7 3003 000	Recoil Starter Assembly No.5 【For RG-MX】
⑰-1	7 3003 100	Recoil Starter Body No.5 【For RG-MX】
⑰-2	7 3003 200	Oneway Clutch No.5 【For RG-MX】
⑱	2 3813 001	Screw Set 【For RG-MX】
	7 1608 001	Glowplug No.8
	7 1802 030	Flywheel No.2E
	7 2103 520	Exhaust Header Pipe

The specifications are subject to alteration for improvement without notice.



## CARBURETTOR EXPLODED VIEW & PARTS LIST

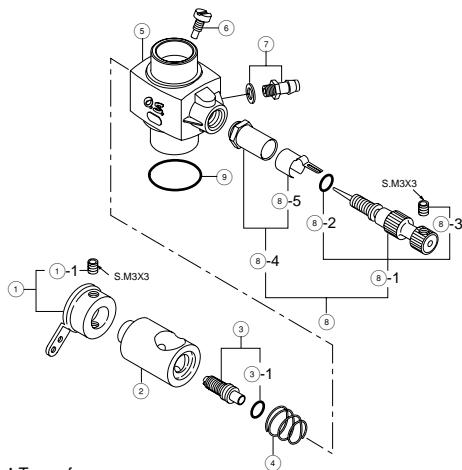

\* Type of screw

C··Cap Screw M··Oval Fillister-Head Screw

F··Flat Head Screw N··Round Head Screw S··Set Screw

No.	Code No.	Description
①	2 4981 405	Throttle Lever Assembly
①-1	2 6381 501	Set-screw
②	2 5381 203	Carburettor Rotor
③	2 6781 309	Mixture Control Valve
③-1	2 4881 824	" O " Ring (2pcs.)
④	2 6781 506	Rotor Spring
⑤	2 5382 100	Carburettor Body
⑥	2 5381 220	Rotor Guide Screw
⑦	2 2681 953	Fuel Inlet
⑧	2 7881 900	Needle Valve Assembly
⑧-1	2 4981 959	Needle
⑧-2	2 4981 837	" O " Ring (2pcs.)
⑧-3	2 6381 501	Set-screw
⑧-4	2 7381 940	Needle Valve Holder Assembly
⑧-5	2 6711 305	Ratchet Spring
⑨	2 9015 019	Carburettor Rubber Gasket

The specifications are subject to alteration for improvement without notice.

## O.S. GENUINE PARTS & ACCESSORIES

### ■ GLOW PLUG



**No.8**  
(71608001)

**A5**  
(71605100)

### ■ MARINE UNIVERSAL JOINT

**4mm** (22442009)



### ■ SUPER JOINT TUBE 21

(72106300)



### ■ T-2030 TUNED SILENCER

(72106030)



### ■ SUPER FILTER

(72403050)



(L)

### ■ CRANKSHAFT CLAMP

**1521**  
(71530200)

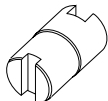

### ■ LOCK WASHER

**M3 (10sets)**  
(55500002)

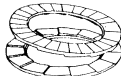

### ■ DUST CAP SET

$\phi 3$  (73300305)  
(For carburetor nipple)

$\phi 8$  (73300812)  
(For T-2030 tuned silencer)

### ■ LONG SOCKET WRENCH WITH PLUG GRIP

(71521000)

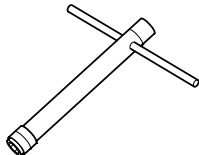

# MAX-21RG-M THREE VIEW DRAWING

## SPECIFICATIONS

■ Displacement	3.46cc/0.211cu.in.
■ Bore	16.6mm/0.654in.
■ Stroke	16.0mm/0.630in.
■ Practical R.P.M.	3,000~35,000r.p.m.
■ Power output	1.7ps/28,000r.p.m.
■ Weight	317g/11.18oz.

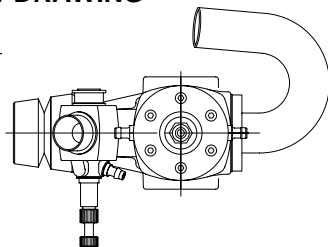

## Dimensions(mm)

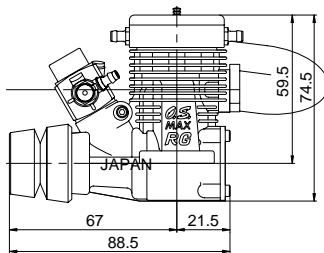
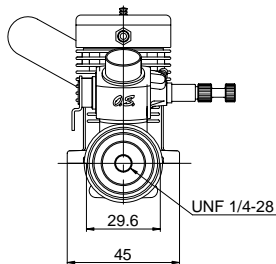
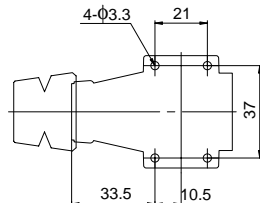

# MAX-21RG-MX THREE VIEW DRAWING

## SPECIFICATIONS

■ Displacement	3.46cc/0.211cu.in.
■ Bore	16.6mm/0.654in.
■ Stroke	16.0mm/0.630in.
■ Practical R.P.M.	3,000~35,000r.p.m.
■ Power output	1.7ps/28,000r.p.m.
■ Weight	389g/13.72oz.

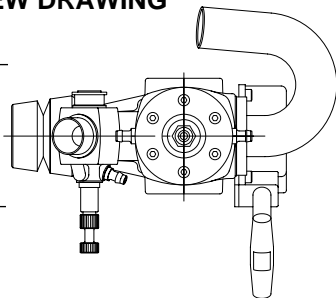

## Dimensions(mm)

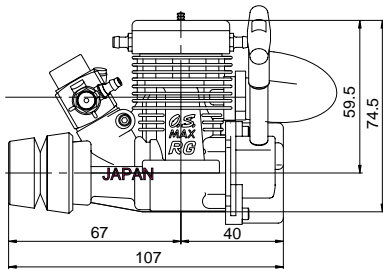
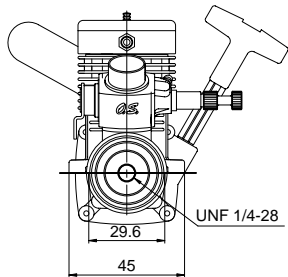
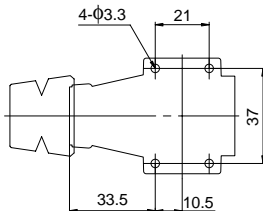

# MEMO

---

---

---

---

---

---

---

---

---

---



***O.S. ENGINES MFG.CO.,LTD.***

6-15 3-Chome Imagawa Higashisumiyoshi-ku  
Osaka 546-0003, Japan TEL. (06) 6702-0225

FAX. (06) 6704-2722

URL : <http://www.os-engines.co.jp>