

---

---

# ***O.S. ENGINE***

# **MAX-32SX-MX**

---

---

## **OWNER'S INSTRUCTION MANUAL**

It is of vital importance, before attempting to operate your engine, to read the general **'SAFETY INSTRUCTIONS AND WARNINGS'** section on pages 2-5 of this booklet and to strictly adhere to the advice contained therein.

- Also, please study the entire contents of this instruction manual, so as to familiarize yourself with the controls and other features of the engine.
- Keep these instructions in a safe place so that you may readily refer to them whenever necessary.
- It is suggested that any instructions supplied with the vehicle, radio control equipment, etc., are accessible for checking at the same time.

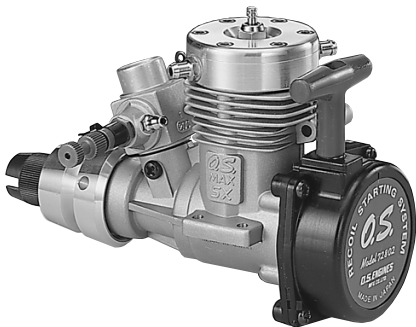

## CONTENTS

SAFETY INSTRUCTIONS AND WARNINGS ABOUT YOUR O.S. ENGINE.....	2~5	IF THE ENGINE FAILS TO START.....	13
INTRODUCTION, BASIC ENGINE PARTS.....	6	ADJUSTMENT.....	13~15
INSTALLATION.....	7	CARE AND MAINTENANCE.....	15~16
NOTES CONCERNING THE RECOIL STARTER.....	7~8	O.S. GENUINE PARTS & ACCESSORIES.....	16
GLOWPLUG.....	8~9	THREE VIEW DRAWING.....	17
TOOLS, ACCESSORIES, etc.....	9~10	ENGINE EXPLODED VIEW.....	18
CARBURETTOR CONTROLS.....	11	ENGINE PARTS LIST.....	19
STARTING & INITIAL RUNNING-IN('Breaking-in).....	12~13	CARBURETTOR EXPLODED VIEW & PARTS LIST.....	20

## **SAFETY INSTRUCTIONS AND WARNINGS ABOUT YOUR O.S. ENGINE**

Remember that your engine is not a "toy", but a highly efficient internal-combustion machine whose power is capable of harming you, or others, if it is misused.

As owner, you, alone, are responsible for the safe operation of your engine, so act with discretion and care at all times.

If at some future date, your O.S. engine is acquired by another person, we would respectfully request that these instructions are also passed on to its new owner.

- The advice which follows applies basically to ALL MODEL ENGINES and is grouped under two headings according to the degree of damage or danger which might arise through misuse or neglect.



### **WARNINGS**

These cover events which might involve serious (in extreme circumstances, even fatal) injury.



### **NOTES**

These cover the many other possibilities, generally less obvious sources of danger, but which, under certain circumstances, may also cause damage or injury.



## WARNINGS

- Never touch, or allow any object to come into contact with, the rotating propeller and do not crouch over the engine when it is running.
- Model engine fuel is poisonous. Do not allow it to come into contact with the eyes or mouth. Always store it in a clearly marked container and out of the reach of children.
- Model engine fuel is also highly flammable. Keep it away from open flame, excessive heat, sources of sparks, or anything else which might ignite it. Do not smoke or allow anyone else to smoke, near to it.



- Never operate your engine in an enclosed space. Model engines, like automobile engines, exhaust deadly carbon-monoxide. Run your engine only in an open area.
- Model engines generate considerable heat. Do not touch any part of your engine until it has cooled. Contact with the muffler (silencer), cylinder head or exhaust header pipe, in particular, may result in a serious burn.





## NOTES

- This engine was designed for model boats. Do not attempt to use it for any other purpose.
- Mount the engine in your model securely, following the manufacturers' recommendations, using appropriate screws and lock-nuts.
- Fit an effective silencer (muffler). Frequent close exposure to a noisy exhaust (especially in the case of the most powerful high-speed engines) may eventually impair your hearing and such noise is also likely to cause annoyance to others over a wide area.
- For their safety, keep all onlookers (especially small children) well back (at least 20 feet or 6 meters) when preparing your model for running.
- Take care that the glowplug clip or battery leads do not come into contact with the propeller or any other rotating parts. Also check that the linkage to the throttle arm is secure.
- If your engine does not have a built-in recoil starter, use an electric starter. The wearing of safety glasses is also strongly recommended.
- When handling the boat immediately prior to launching, be especially cautious. Keep the propeller and other rotating parts away from you.



## NOTES

- Adjust the throttle linkage so that the engine stops when the throttle stick and trim lever on the transmitter are fully retarded. Alternatively, the engine may be stopped by cutting off the fuel supply. Never try to stop the engine physically.
- Warning! Immediately after a glowplug-ignition engine has been run and is still warm, conditions sometimes exist whereby it is just possible for the engine to abruptly restart if it is rotated over compression WITHOUT the glowplug battery being reconnected.
- If your engine is fitted with a recoil starter, pull the operating handle straight out when starting the engine, so that the cord does not rub against the hull or engine. This will help prevent the cord from being damaged by abrasion or engine heat.
- Do not extend the starter cord more than 45cm (18"). Do not abruptly release the operating handle. Allow the cord to rewind smoothly while still holding the handle.
- Do not attempt to disassemble the recoil starter (if fitted). If you do so, the very strong spring inside will be suddenly ejected. This can be very dangerous.

The O.S. MAX-32SX-MX is a high-performance water-cooled marine engine for small radio-controlled boats, especially scale and sport type hulls. The MAX-32SX-MX incorporates a recoil starter system which provides easy, positive starting, while eliminating the need for an electric starter and starter-battery.

### NOTE

- With this engine, the piston will feel tight at the top of its stroke when the engine is cold.
- This is normal. The piston and cylinder are designed to achieve a perfect running clearance when they reach their normal running temperatures. We do not recommend running your boat on the sea, or in any other saltwater environment. Under such conditions, it is difficult to prevent the engine from becoming corroded and, eventually, inoperative.

## BASIC ENGINE PARTS

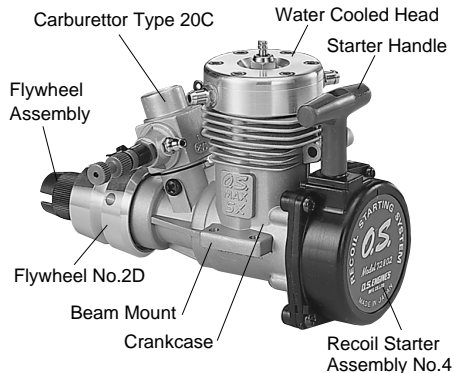

## INSTALLING THE GLOWPLUG

Install the washer on the glowplug and insert carefully into cylinder-head, making sure that it is not cross-threaded before tightening firmly.

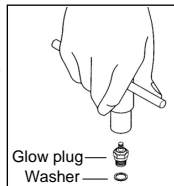

---

## INSTALLATION

1. Make sure that the engine mounting beams in the hull are parallel, with their top surfaces in the same plane. If they are not, the engine will not rest firmly as the engine mounting faces (undersides of the mounting lugs) are precision machined to be flat and in the same plane. Poor installation may not only cause vibration, erratic running and loss of performance, but may also damage the engine itself by deforming the crankcase, cylinder, etc.
2. The mounting beams and adjacent hull structure should be as rigid as possible so that the engine may develop its full performance. Use 3mm steel screws, such as Allen socket-head type, with locknuts, for bolting the engine to the mounting beams.
3. If the holes in the mounting beams do not align exactly with the engine's mounting lugs, enlarge them slightly with a needle file so that the mounting screws pass through the holes smoothly without being forced.

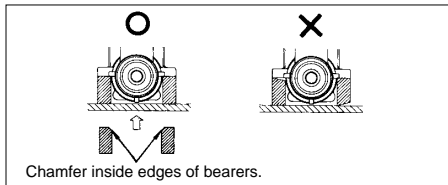

---

## NOTES CONCERNING THE RECOIL STARTER

### REMINDER!

- ◆ Do not attempt to disassemble the recoil starter. If you do so, the very strong spring inside will be suddenly ejected. This can be very dangerous.
- ◆ Do not extend the starter cord more than 45cm(18"). Do not abruptly release the operating handle. Allow the cord to rewind smoothly while still holding the handle.
- ◆ Pull the operating handle straight out when starting the engine, so that the cord does not rub against the vehicle body or engine. This will help prevent the cord from being damaged by abrasion or engine heat.



- ◆ **Try to avoid spilling fuel over the starter unit and its cord. Some fuels have a detrimental effect on these parts.**
- ◆ **The starter prevents the engine from being rotated in the wrong direction. The unit will be damaged if you attempt to force the flywheel in the opposite direction (i.e. clockwise when viewed from the crankshaft end).**

**NOTE: Because, in the interests of personal safety, dismantling of the starter mechanism is strongly discouraged, the Recoil Starter is available for replacement only as a pre-assembled unit. However, some related parts, such as Starting Shaft and Rear Adaptor, are obtainable separately. (See Parts List.)**

---

## **GLOWPLUG**

Since the compatibility of the glowplug and fuel can have a marked effect on performance and reliability, it is suggested that the user selects the R/C type plug found most suitable after practical experiments. Generally, for a fuel containing about 30% nitromethane, a medium heat range glowplug will be suitable.

For higher nitro fuel, a cold rated plug may be required, whereas, for lower nitro fuel, a hot rated plug may be best. However, the O.S. No.8 glowplug may be employed irrespective of the nitro content of the fuel.

### **The role of the glowplug**

With a glowplug engine, ignition is initiated by the application of a 1.5-volt power source. When the battery is disconnected, the heat retained within the combustion chamber remains sufficient to keep the plug filament glowing, thereby continuing to keep the engine running. Ignition timing is 'automatic': under reduced load, allowing higher rpm, the plug becomes hotter and, appropriately, fires the fuel/air charge earlier; conversely, at reduced rpm, the plug becomes cooler and ignition is retarded.

### **Glowplug life**

Particularly in the case of very high performance engines, glowplugs must be regarded as expendable items. However, plug life can be extended and engine performance maintained by careful use, i.e.:

- Install a plug suitable for the engine.
- Use fuel containing a moderate percentage of nitromethane unless more is essential for racing events.

- Do not run the engine too lean and do not leave the battery connected while adjusting needle.

### **When to replace the glowplug**

Apart from when actually burned out, a plug may need to be replaced because it no longer delivers its best performance, such as when:

- Filament surface has roughened and turned white.
- Filament coil has become distorted.
- Engine tends to cut out when idling.
- Starting qualities deteriorate.
- Foreign matter has adhered to filament or plug body has corroded.

---

## **TOOLS, ACCESSORIES, etc.**

The following items are necessary for operating the engine.

### **FUEL**

Generally, it is suggested that the user selects a fuel that is commercially available for model two-stroke engines and contains between 10% and 30% nitromethane. As a starting point, we recommend a fuel containing 10% nitromethane, changing to a fuel containing more nitro if necessary.

When the brand of fuel is changed, or the nitro content increased, it is advisable to repeat the running-in procedure referred to in the RUNNING-IN paragraphs. For consistent performance and long engine life, it is essential to use a good quality fuel containing NOT LESS THAN 18% lubricant. Please note that with high-nitro fuels, although power may be increased for competition purposes, glowplug elements do not last as long and engine life will be shortened.

### **REMINDER!**

 **Model engine fuel is poisonous. Do not allow it to come into contact with the eyes or mouth. Always store it in a clearly marked container and out of the reach of children.**

 **Model engine fuel is also highly flammable. Keep it away from open flame, excessive heat, sources of sparks, or anything else which might ignite it. Do not smoke or allow anyone else to smoke, near to it.**

## PROPELLER

Use well balanced propellers only. As the ideal diameter, pitch and shape vary according to the size, weight and type of model, final selection can be made after practical experiment. As a starting point, suggested propeller diameter is 42-45mm with a pitch/dia ratio of 1.0-1.1 for Vee type hulls.

## REMINDER!



**Never touch, or allow any object to come into contact with, the rotating propeller and do not crouch over the engine when it is running.**

## GLOWPLUG BATTERY

The power source for heating the glowplug may be either a large, heavy-duty 1.5-volt cell, or a 2-volt rechargeable lead-acid cell with extended leads (or a resistance) to reduce the applied voltage to approximately 1.5-v.

## BATTERY LEADS

These are used to conduct current from the battery to the glowplug. For convenience, special leads with a suitable clip to fit the glowplug terminal, are commercially available.

## LONG SOCKET WRENCH

Recommended for easy removal and replacement of the deeply recessed glowplug, the O.S. Long Socket Wrench incorporates a special grip.(See Parts List)

## FUEL BOTTLE OR PUMP

For filling the fuel tank, a simple, polyethylene "squeeze" bottle, with a suitable spout, is required. Alternatively, one of the purpose-made manual or electric fuel pumps may be used to transfer fuel directly from your fuel container to the fuel tank.

## FUEL CAN FILTER

Fit a filter to the outlet tube of your refueling container to prevent entry of foreign matter into the fuel tank. O.S. 'Super-Filters' (large and small) are available as optional extras.

## SILICONE FUEL LINE

This is required for the connection between the fuel tank and engine, also for the water-cooling system.

## CARBURETTOR CONTROLS

Two adjustable controls are provided on this carburettor.

### ● The Needle Valve:

When set to produce maximum power at full throttle, this establishes the basic fuel/air mixture strength. This is then maintained by the carburettor's automatic mixture control system to cover the engine's requirements at reduced throttle settings.

### ● The Mixture Control Valve (Mixture Control Screw):

For adjusting the mixture strength at part-throttle and idling speeds, to obtain steady idling and smooth acceleration to medium speeds. The Mixture Control Valve has been factory set for the approximate best result. First, run the engine as received, and re-adjust the Mixture Control Valve only when necessary.

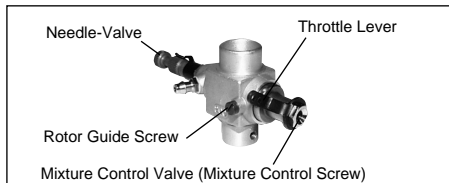

## ■ REALIGNMENT OF MIXTURE CONTROL VALVE

In the course of making carburettor adjustments, it is just possible that the Mixture Control Valve may be inadvertently screwed in or out too far and thereby moved beyond its effective adjustment range.

Its basic setting can be reestablished as follows :

The basic ( factory ) setting is as shown in the main sketch, i. e. with the shoulder portion 'A' exactly at a tangent to the throttle rotor hole.

To return the Mixture Control Valve to its original position, first screw in the Mixture Control Valve, while looking into the rotor hole. Then gradually unscrew the Mixture Control Valve until 'A' is precisely tangential to the rotor hole (i.e. so that 'A' and 'B' are superimposed) as in the main sketch.

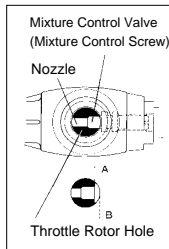

## STARTING & INITIAL RUNNING-IN('Breaking-in')

For long life and high performance, every engine needs to be 'run-in' or 'broken-in'. With care, running-in of the MAX-32SX-MX can be carried out with it installed in the boat. Be sure to use a muffler-pressurized fuel system.

The following procedure is suitable for this engine when the O.S. E-3030 silencer and a fuel containing up to 5-10% nitromethane are used.

- ◆ Use the same fuel as is to be employed for all initial running and containing NOT LESS THAN 18% lubricant.
- ◆ Temporarily remove the glow-plug to check that it glows bright red when energized.
- ◆ Open the Needle-Valve 1 1/2 turns from the fully closed position.
- ◆ Switch on the transmitter and receiver and set the throttle very slightly opened from the idling position.

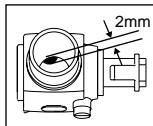
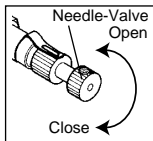

- ◆ Pull the starter handle briskly straight out several times to start the engine.

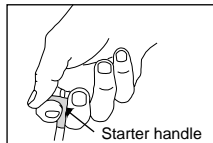

### Attention:

It is vitally important to set the throttle at the correct position before starting the engine. If the engine is allowed to run with the throttle too far open under "no load" conditions (i.e. with the hull out of the water,) it will rapidly over-heat and may be seriously damaged.

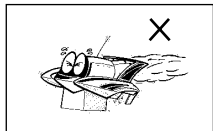

- ◆ When the engine is brand new it may be started out of the water, but must be run on a very rich needle-valve setting for the first few minutes. This will provide extra lubrication and avoid overheating.

- ◆ Next restart the engine, disconnect the glowplug battery and lower the boat into the water, gradually opening the throttle sufficiently to prevent the engine from stalling as the propeller takes up the load. If the engine stops due to being over-rich, close the needle-valve 30° and try again.

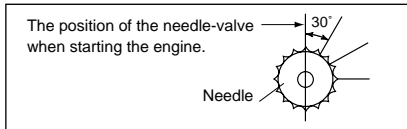

- ◆ Check that cooling water is being discharged (most important) then release the boat and run it under radio-control until one tank of fuel has been consumed. Now close the needle-valve approximately 30° and run the craft for another full tank of fuel. Repeat this procedure until a total of 5 tanks has been consumed. If the engine stops at medium speed, close the mixture control screw 45° to 90° and try again. The completion of this stage marks the conclusion of the initial running-in period.
- ◆ To stop the engine, close the throttle to idling speed, then shut it off completely with the trim lever of the transmitter or pinch the fuel delivery line.

---

## IF THE ENGINE FAILS TO START

### Check the following:

- ◆ Glowplug battery discharged or glowplug defunct.
- ◆ Fuel not reaching carburettor.
- ◆ Engine flooded. Do not over-prime. (This could also cause a hydraulic lock and damage the engine on application of the electric starter.) Remove glow-plug, close needle-valve and apply starter to pump out surplus fuel.

---

## ADJUSTMENT

- ◆ Open the throttle slightly from the idling position and start the engine, following the procedure described previously.
- ◆ Lower the boat into the water, gradually open the throttle and run the boat straight ahead for 20 to 30 meters at full throttle. Now return the model and close the needle-valve 20 to 30°. Repeat the run, taking note of the improvement in speed.
- ◆ Continue with further runs, gradually closing the needle-valve (20 to 30° at a time) until no further increase in speed is obtained.

- ◆ If the needle-valve is closed beyond the optimum setting, the model will slow down, accompanied by visibly diminished exhaust smoke. In this case, immediately throttle down and return the model to shore. Re-open the needle-valve approximately one-half turn and repeat the runs until the optimum needle setting is found.
- ◆ Aim to have the model achieving its highest performance after the engine has consumed about one quart of fuel. Having found the optimum needle-valve setting, make a note of the number of turns necessary to re-establish this from the closed position.
- ◆ With the engine run-in and the optimum needle-valve setting determined, the mixture control valve should be checked as follows:
- ◆ Launch the boat and gradually open the throttle to its fullest extent. If at this point, the engine puffs out a good deal of smoke and does not accelerate smoothly and rapidly, it is a sign that the idling mixture is too rich. Therefore, turn the mixture control screw clockwise 45 to 60°. Repeat the run and recheck the result.
- ◆ If, on the other hand, the idling mixture is too lean, the engine is likely to speed up momentarily, then cut out abruptly when the throttle is re-opened. In this case, first turn the mixture control screw counter-clockwise 90° to make sure that the mixture has become richer, then make incremental adjustments, each way, until an acceptable balance between rich and lean settings is achieved. Carry out these adjustments patiently under actual running conditions, until the engine responds quickly and positively to throttle movements. Use a small screwdriver to adjust the mixture control valve via its slotted screwhead in the center of the outer end of the throttle rotor.
- ◆ With the optimum mixture control valve position, light smoke is visible during high-speed running and engine rpm increases smoothly during acceleration. Remember that, if the engine is operated with the fuel/air mixture slightly too lean, it will overheat and run unevenly or cut out. As with all engines, it is wise to set both valves a little on the rich side of the best rpm setting, as a safety measure.

◆ When the best balance of mixture adjustments has been determined and, especially as the engine becomes fully run-in, it will probably be found that the idling speed has increased.

Readjust the throttle opening by means of the trim lever on the transmitter, so that the lowest idling speed, without risk of stalling the engine, may be obtained.

---

## CARE AND MAINTENANCE

To ensure that you obtain long life and peak performance from your engine, observe the following.

- ① As previously observed, foreign matter in the fuel can cause problems. Therefore:
  - rinse out the fuel tank with methanol or fuel before installing it.
  - Install a fuel filter to the fuel delivery tube between tank and carburettor.
  - Install a fuel filter to the outlet of your squeeze bottle, or to the pump inlet if you use a manual or electric pump. \*
  - do not leave your fuel container open needlessly.

\* O.S. 'Super-Filters' (large and small) are available, as optional extras, to deal with this problem.

One of these filters, fitted to the outlet tube inside your refuelling container, will prevent the entry of foreign material into the fuel tank.

- ② Do not forget to clean the filters regularly to remove dirt and lint that accumulate on the filter screens. Also, clean the carburettor itself occasionally.
- ③ At the end of each operating session, drain out any fuel that may remain in the fuel tank. Afterwards, energize the glowplug and try to restart the engine, to burn off any fuel that may remain inside the engine. Repeat this procedure until the engine fails to fire. Leaving fuel residues within the engine can result in difficult starting after a period of storage. It may also cause corrosion. To reduce such risks, it is helpful to inject some corrosion inhibiting oil into the engine's air intake. Rotate the engine many times to distribute the oil to all the working parts.



- ④ Drain the water remaining in the water cooling head, and wash out with methanol, then inject corrosion-inhibiting or moisture-displacing oil.
- ⑤ When cleaning the exterior of the engine, use methanol or kerosene. Do not use gasoline or any solvent that might damage the silicone fuel tubing or any plastic parts of the boat hull.
- ⑥ When the engine is not in use remove the glow-plug and rinse out the interior with kerosene (not gasoline), by rotating the crankshaft. Shake out residue, then inject light machine-oil through the plug hole again rotating the shaft to distribute the protective oil to all working parts.

---

## O.S. GENUINE PARTS & ACCESSORIES

- O.S. Glow Plug  
No.8  
(71608001)



- E-3030 Silencer  
(23325020)

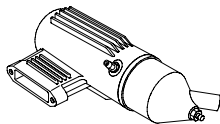

- 883  
Universal Silencer  
(72113000)

- Long Socket Wrench  
With Plug Grip  
(71521000)

- Super Filter  
(72403050)

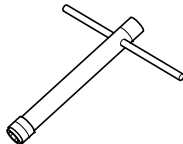

## THREE VIEW DRAWING

### SPECIFICATIONS

■ Displacement	5.23 cc/0.319 cu. in
■ Bore	19.5 mm/0.768 in
■ Stroke	17.5 mm/0.689 in
■ Practical r.p.m.Range	2,500~21,000 r.p.m.
■ Output	1.1 bhp / 17,000 r.p.m.
■ Weight	423g/14.92 oz.

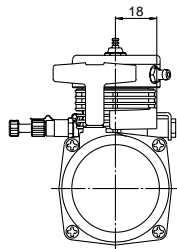
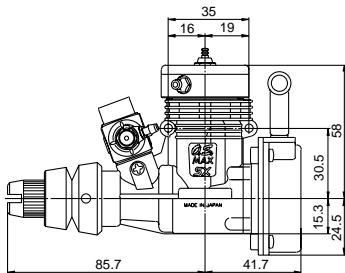
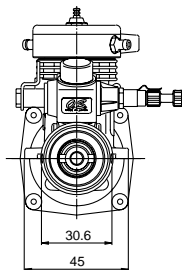
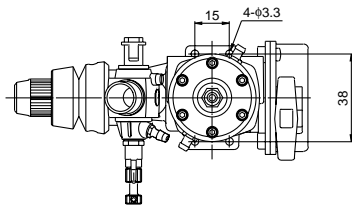

Dimensions (mm)

# EXPLODED VIEW

-18-

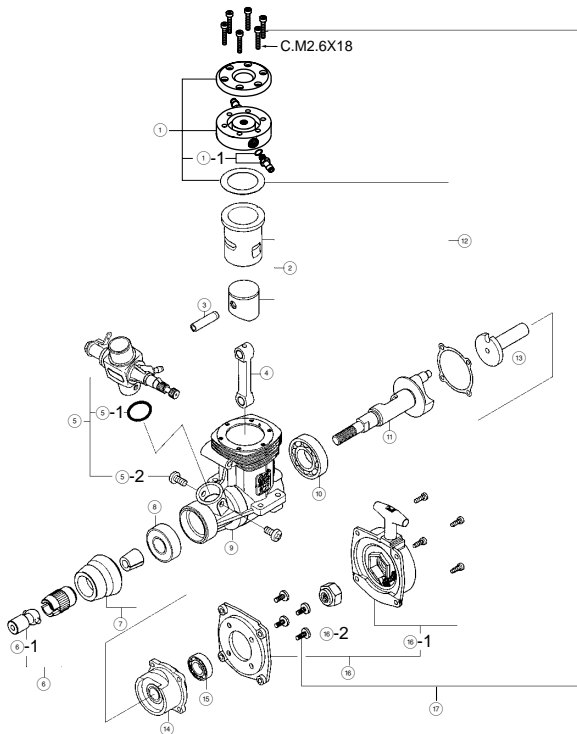

\* Type of screw C···Cap Screw M···Oval Fillister-Head Screw  
 F···Flat Head Screw N···Round Head Screw S···Set Screw

## ENGINE PARTS LIST

No.	Code No.	Description
①	2 3441 000	Water Cooled Head Assembly
①-1	2 4025 923	Nipple No.2
②	2 3403 000	Cylinder & Piston Assembly
③	2 3406 000	Piston Pin
④	2 3405 000	Connecting Rod
⑤	2 3481 000	Carburettor Complete(Type 20C)
⑤-1	2 2615 000	Carburettor Rubber Gasket
⑤-2	2 3081 706	Carburettor Retaining Screw(2pcs.)
⑥	2 2442 009	Universal Joint Assembly(4.0mm)
⑥-1	2 2442 102	Joint Ball(4.0mm)
⑦	7 1802 020	Flywheel No.2D
⑧	2 2831 000	Crankshaft Ball Bearing(Front)
⑨	2 3401 000	Crankcase
⑩	2 3430 000	Crankshaft Ball Bearing(Rear)
⑪	2 3402 010	Crankshaft
⑫	2 3414 000	Gasket Set
⑬	2 2921 210	Starting Shaft
⑭	2 2921 110	Rear Housing
⑮	2 7381 210	Starting Shaft Bearing
⑯	7 3201 000	Recoil Starter Assembly No.2
⑯-1	7 3201 100	Recoil Starter Body
⑯-2	7 2801 102	One-way Clutch
⑰	2 2913 030	Screw Set
	7 1608 001	Glowplug No.8

The specifications are subject to alteration for improvement without notice.

## 20C CARBURETTOR EXPLODED VIEW & PARTS LIST

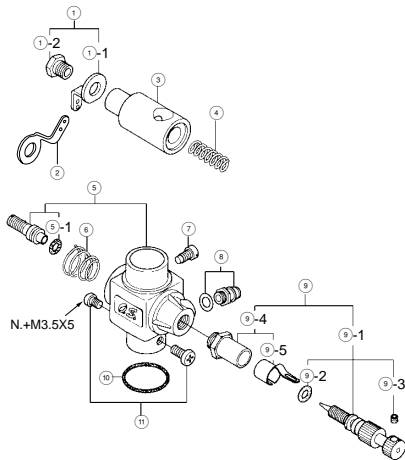

\*Type of screw

C··Cap Screw M··Oval Fillister-Head Screw

F··Flat Head Screw N··Round Head Screw S··Set Screw

No.	Code No.	Description
①	23481400	Throttle Lever Assembly
①-1	22781410	Throttle Lever
①-2	22781420	Throttle Lever Fixing Screw
②	22781411	Throttle Lever
③	23481200	Carburettor Rotor
④	23481650	Mixture Control Valve Spring
⑤	23481100	Carburettor Body
⑤-1	24881824	"O"Ring (2pcs.)
⑥	26781506	Rotor Spring
⑦	45581820	Rotor Guide Screw
⑧	22681953	Fuel Inlet
⑨	27681900	Needle Valve Assembly
⑨-1	27681970	Needle
⑨-2	24981837	"O"Ring (2pcs.)
⑨-3	26381501	Set Screw
⑨-4	27381940	Needle Valve Holder
⑨-5	26711305	Ratchet Spring
⑩	22615000	Carburettor Rubber Gasket
⑪	23081706	Carburettor Retaining Screw

The specifications are subject to alteration for improvement without notice.



***O.S. ENGINES*** MFG.CO.,LTD.

6-15 3-Chome Imagawa Higashisumiyoshi-ku  
Osaka 546-0003, Japan TEL. (06) 6702-0225  
FAX. (06) 6704-2722