

1/8th Scale Gas Powered 4WD Racing Buggy MBX-6 Parts List

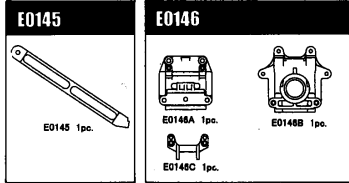

E0051 MBX-6 INSTRUCTION MANUAL  
 E0052 MBX-6 DECAL  
 E0053 MBX-6 DECAL  
 B0103 FUEL FILTER L  
 B0104 FUEL FILTER S  
 E0104-B CENTER DIFF. MOUNT  
 C0107D PIVOT BALL  $\phi$ 7mm  
 E0117 TITANIUM REAR UPPER ARM  
 B0118 AIR FILTER SET  
 B0119 AIR FILTER  
 E0123 LOWER ARM SHAFT  
 E0124 REAR LOWER ARM SHAFT S  
 C0129 FRONT UPPER ARM ROD  
 E0135 SUS. ARM SPACER  
 E0142/1 AL. KING PIN BALL  
 E0143 FRONT LOWER ARM SUPPORT  
 E0144 REAR LOWER ARM SUPPORT  
 E0145 REAR TENSION ROD  
 E0146 GEAR BOX

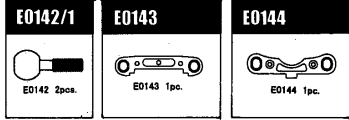
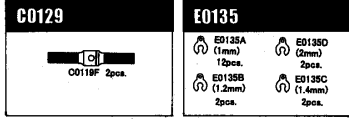
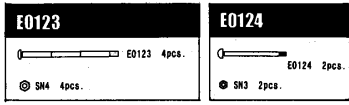
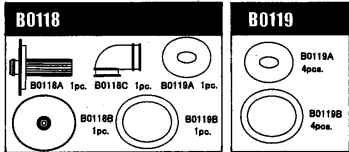
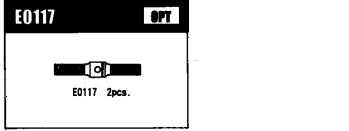
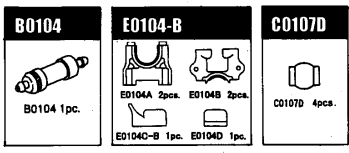
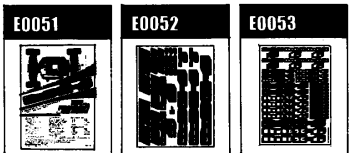
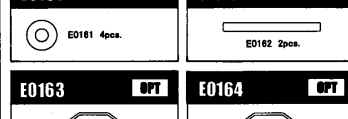
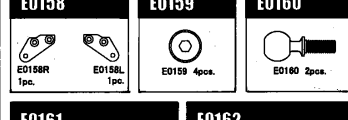
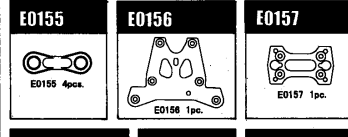
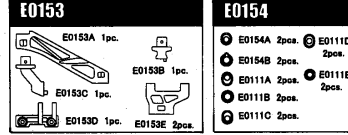
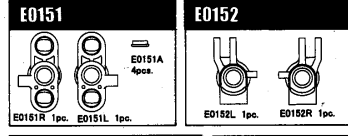
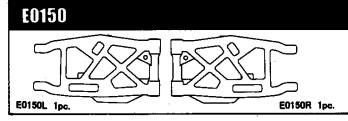
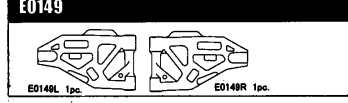
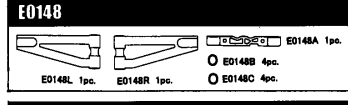
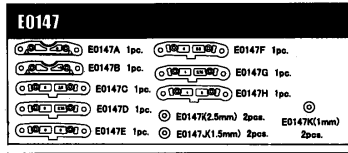

E0147 LOWER ARM MOUNT  
 E0148 FRONT UPPER ARM  
 E0149 FRONT LOWER ARM  
 E0150 REAR LOWER ARM  
 E0151 FRONT UPRIGHT  
 E0152 REAR UPRIGHT  
 E0153 BUSH SET  
 E0154 ANTI-ROLL BAR LINK  
 E0155 FRONT UPPER PLATE  
 E0156 CENTER DIFF. MOUNT PLATE  
 E0157 FRONT UPRIGHT ARM  
 E0158 ADJUST NUT  
 E0160 FRONT LOWER KINGPIN BALL  
 E0161 FRONT TRACK WIDTH ADJUST SPACER  
 E0162 FRONT UPPER ARM SHAFT  
 E0163 FRONT ANTI-ROLL BAR  $\phi$ 2.2mm  
 E0164 FRONT ANTI-ROLL BAR  $\phi$ 2.3mm

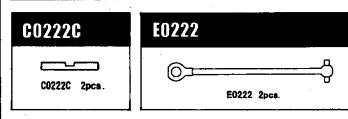
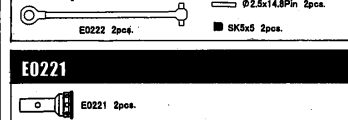
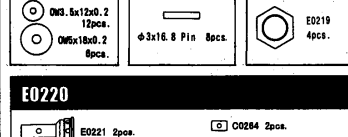
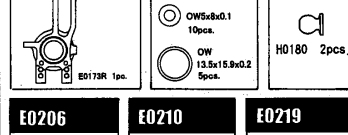
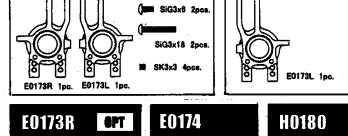
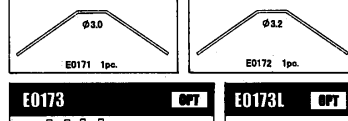
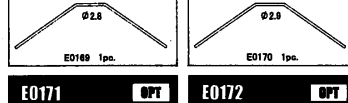
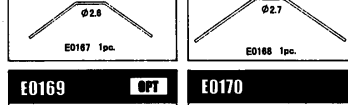
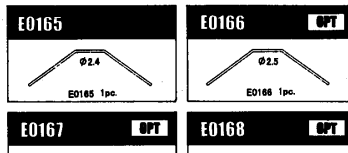

E0165 FRONT ANTI-ROLL BAR  $\phi$ 2.4mm  
 E0166 FRONT ANTI-ROLL BAR  $\phi$ 2.5mm  
 E0167 FRONT ANTI-ROLL BAR  $\phi$ 2.6mm  
 E0168 REAR ANTI-ROLL BAR  $\phi$ 2.7mm  
 E0169 REAR ANTI-ROLL BAR  $\phi$ 2.8mm  
 E0170 REAR ANTI-ROLL BAR  $\phi$ 2.9mm  
 E0171 REAR ANTI-ROLL BAR  $\phi$ 3.0mm  
 E0172 REAR ANTI-ROLL BAR  $\phi$ 3.2mm  
 E0173 AL REAR UPRIGHT SET  
 E0173L AL REAR UPRIGHT L  
 E0173R AL REAR UPRIGHT R  
 E0174 WASHER SET  
 H0180 REAR UPRIGHT BALL  
 E0206 PIN  $\phi$ 3x16.8 (8pcs.)  
 E0210 PIN  $\phi$ 3x16.8 (8pcs.)  
 E0219 SELF-LOCKING WHEEL NUT  
 E0220 F/R UNIVERSAL JOINT SET  
 E0221 F/R AXLE SHAFT  
 C0222C DIFF. SHAFT  
 E0222 F/R DRIVE SHAFT

1/8スケールMBX-6パーツリスト

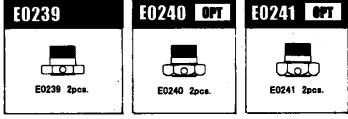
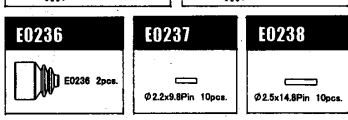
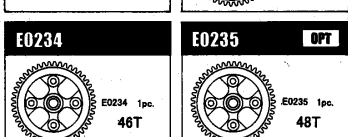
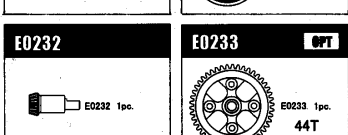
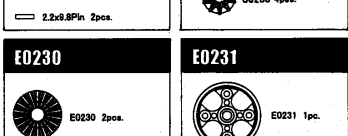
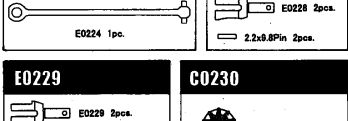
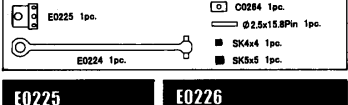
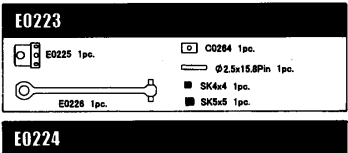



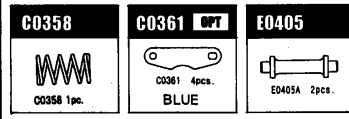
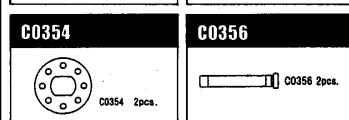
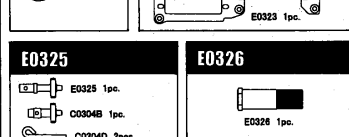
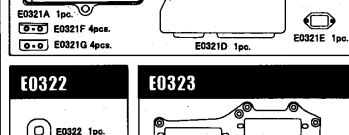
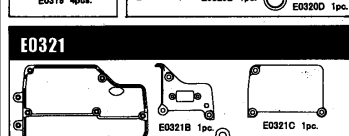
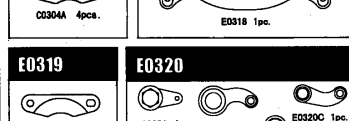
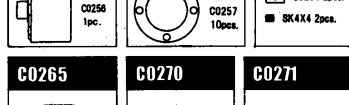
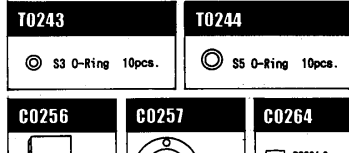



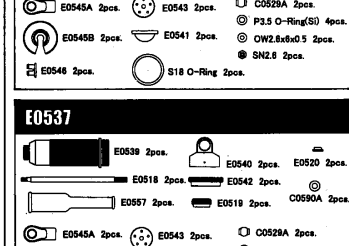
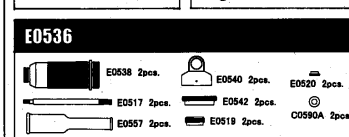
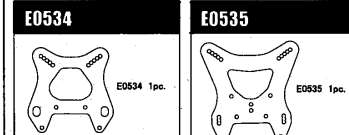
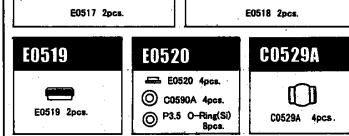
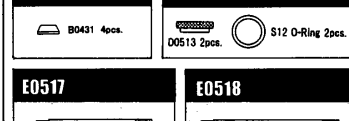
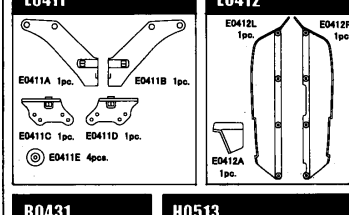
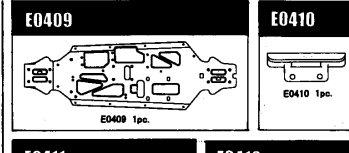



E0223 CENTER UNIVERSAL JOINT (78.5) SET  
 E0224 CENTER UNIVERSAL JOINT (103) SET  
 E0225 JOINT CLIP  
 E0226 CENTER DRIVE SHAFT (78.5)  
 E0227 CENTER DRIVE SHAFT (103)  
 E0228 F/R CUP JOINT  
 E0229 CENTER CUP JOINT  
 E0230 DIFF. GEAR 10T  
 E0231 CONICAL GEAR 44T  
 E0232 BEVEL GEAR  
 E0233 SPUR GEAR 44T  
 E0234 SPUR GEAR 46T  
 E0235 SPUR GEAR 48T  
 E0236 JOINT BOOTS  
 E0237 JOINT PIN ( $\phi$ 2.2x9.8) (FOR E0228/E0229)  
 E0238 JOINT PIN ( $\phi$ 2.5x14.8) (FOR E0221)  
 E0239 WHEEL HUB  
 E0240 WIDE OFFSET WHEEL HUB 1mm  
 E0241 WIDE OFFSET WHEEL HUB 2mm



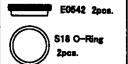

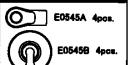

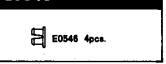
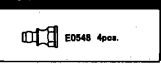
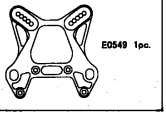
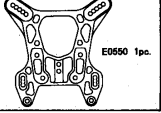
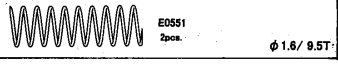
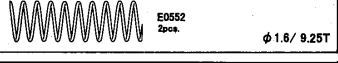
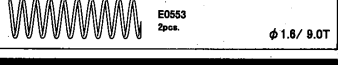
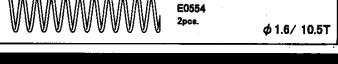
T0243 S3 O-RING  
 T0244 S5 O-RING  
 C0256 DIFF. CASE  
 C0257 GASKET FOR DIFF.  
 C0264 JOINT SHAFT  
 C0265 JOINT PIN (FOR E0225)  
 C0270 JOINT PIN (FOR E0226/E0227)  
 C0271 JOINT PIN (FOR E0222)  
 C0304A BRAKE PLATE  
 E0318 SERVO SAVER PLATE  
 E0319 CONICAL GEAR 44T  
 E0320 BEVEL GEAR  
 E0321 SPUR GEAR 44T  
 E0322 SPUR GEAR 46T  
 E0323 SPUR GEAR 48T  
 E0326 JOINT BOOTS  
 E0327 JOINT PIN ( $\phi$ 2.2x9.8) (FOR E0228/E0229)  
 E0328 JOINT PIN ( $\phi$ 2.5x14.8) (FOR E0221)  
 E0329 WHEEL HUB  
 E0354 WIDE OFFSET WHEEL HUB 1mm  
 E0356 WIDE OFFSET WHEEL HUB 2mm

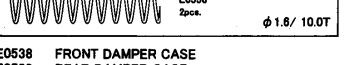



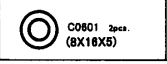
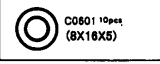
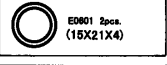
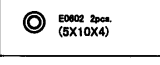
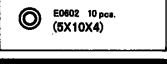
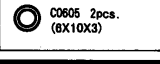
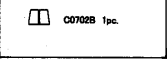
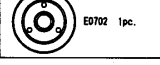
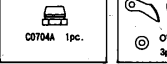
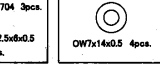
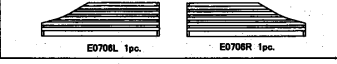
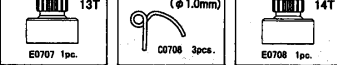
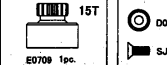
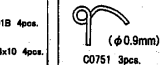
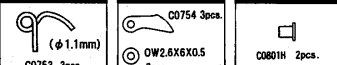

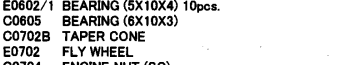

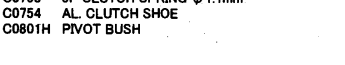



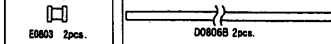
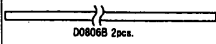

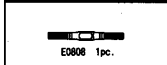
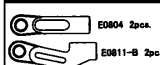
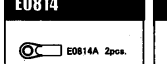
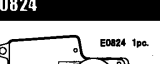
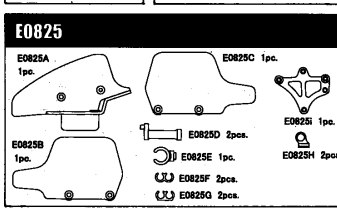

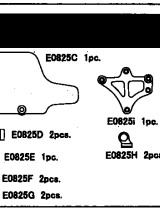
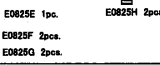

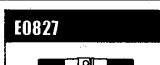

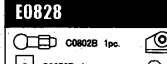
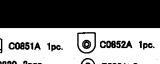
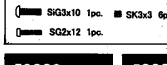

E0409 CHASSIS  
 E0410 FRONT BUMPER  
 E0411 WING STAY  
 E0412 STONE GUARD  
 B0431 3mm CONE WASHER  
 H0513 SPRING ADJUSTER  
 E0517 FRONT DAMPER SHAFT  
 E0518 REAR DAMPER SHAFT  
 E0519 OIL SEAL CAP  
 E0520 OIL SEAL SET  
 E0529A LINK BALL  
 E0534 FRONT DAMPER SET  
 E0535 REAR DAMPER SET  
 E0536 FRONT DAMPER SET  
 E0537 REAR DAMPER SET

<b>E0538</b>  E0538 2pcs.	<b>E0539</b>  E0539 2pcs.
<b>E0540</b>  E0540 2pcs.	<b>E0541</b>  E0541 4pcs.
<b>E0542</b>  E0542 2pcs. S18 O-Ring 2pcs.	
<b>E0543</b>  E0543 4pcs. (White)	<b>E0544</b>  E0544 4pcs. (Black)
<b>E0545</b>  E0545A 4pcs.  E0545B 4pcs.	
<b>E0546</b>  E0546 4pcs.	<b>E0548</b>  E0548 4pcs.
<b>E0549</b> OPT  E0549 1pc.	<b>E0550</b> OPT  E0550 1pc.
<b>E0551</b> OPT  E0551 2pcs. φ 1.6 / 9.5T	
<b>E0552</b>  E0552 2pcs. φ 1.6 / 9.25T	
<b>E0553</b> OPT  E0553 2pcs. φ 1.6 / 9.0T	
<b>E0554</b> OPT  E0554 2pcs. φ 1.6 / 10.5T	
<b>E0555</b>  E0555 2pcs. φ 1.6 / 10.25T	
<b>E0556</b> OPT  E0556 2pcs. φ 1.6 / 10.0T	

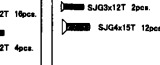
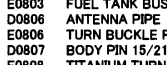
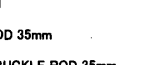
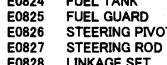









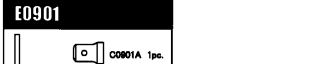

- E0538 FRONT DAMPER CASE
- E0539 REAR DAMPER CASE
- E0540 DAMPER CAP
- E0541 DIAPHRAGM
- E0542 DAMPER SPRING ADJUSTER
- E0543 DAMPER PISTON (φ 1.35 5H)
- E0544 DAMPER PISTON (φ 1.25 6H)
- E0545 DAMPER END
- E0546 DAMPER MOUNT PIVOT BUSH
- E0548 DAMPER MOUNT PIVOT
- E0549 AL. FRONT DAMPER STAY
- E0550 AL. REAR DAMPER STAY
- E0551 FRONT DAMPER SPRING φ 1.6 / 9.5T
- E0552 FRONT DAMPER SPRING φ 1.6 / 9.25T
- E0553 FRONT DAMPER SPRING φ 1.6 / 9.0T
- E0554 REAR DAMPER SPRING φ 1.6 / 10.5T
- E0555 REAR DAMPER SPRING φ 1.6 / 10.25T
- E0556 REAR DAMPER SPRING φ 1.6 / 10.0T

<b>E0557</b>  E0557 4pcs.	
<b>C0601</b>  C0601 2pcs. (8X16X5)	<b>C0601/1</b>  C0601 10pcs. (8X16X5)
<b>E0601</b>  E0601 2pcs. (15X21X4)	<b>E0602</b>  E0602 2pcs. (5X10X4)
<b>E0602/1</b>  E0602 10pcs. (5X10X4)	<b>C0605</b>  C0605 2pcs. (6X10X3)
<b>C0702B</b>  C0702B 1pc.	<b>E0702</b>  E0702 1pc.
<b>C0704</b>  C0704 1pc.	<b>E0704</b> OPT  E0704 3pcs. OW2.5x0.5
<b>E0705</b>  E0705 4pcs. OW7x14x0.5	
<b>E0706</b>  E0706 1pc.	
<b>E0707</b>  E0707 13T	<b>C0708</b>  C0708 3pcs. (φ 1.0mm)
<b>E0708</b> OPT  E0708 14T	
<b>E0709</b> OPT  E0709 15T	<b>C0723</b>  C0723 4pcs. S/JGx10
<b>C0751</b> OPT  C0751 3pcs. (φ 0.9mm)	
<b>C0753</b> OPT  C0753 3pcs. (φ 1.1mm)	<b>C0754</b>  C0754 3pcs. OW2.6X6X0.5
<b>C0801H</b>  C0801H 2pcs.	

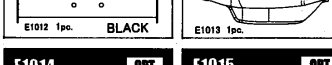
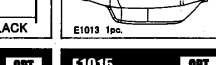
- E0557 DAMPER BOOTS
- C0601 BEARING (8X16X5)
- C0601/1 BEARING (8X16X5) 10pcs.
- E0601 BEARING (15X21X4)
- E0602 BEARING (5X10X4)
- E0602/1 BEARING (5X10X4) 10pcs.
- C0605 BEARING (6X10X3)
- C0702B TAPER CONE
- E0702 FLY WHEEL
- C0704 ENGINE NUT (SQ)
- E0704 AL. CLUTCH SHOE (LIGHT WEIGHT)
- E0705 FLY WHEEL WASHER
- E0706 ENGINE MOUNT
- E0707 CLUTCH BELL 13T
- C0708 3P CLUTCH SPRING φ 1.0mm
- E0708 CLUTCH BELL 14T
- E0709 CLUTCH BELL 15T
- C0723 DAMPER MOUNT FLAT SCREW
- C0751 3P CLUTCH SPRING φ 0.9mm
- C0753 3P CLUTCH SPRING φ 1.1mm
- C0754 AL. CLUTCH SHOE
- C0801H PIVOT BUSH

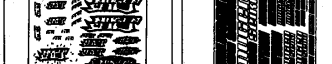
<b>E0803</b>  E0803 2pcs.	<b>D0806</b>  D0806 2pcs.
<b>E0806</b>  E0806 1pc.	<b>D0807</b>  D0807 3pcs.
<b>E0808</b> OPT  E0808 1pc.	<b>E0811-B</b>  E0811-B 2pcs.
<b>E0814</b>  E0814 2pcs.	<b>E0824</b>  E0824 1pc.
<b>E0825</b>  E0825A 1pc.  E0825B 1pc.  E0825C 1pc.  E0825D 2pcs.  E0825E 1pc.  E0825F 2pcs.  E0825G 2pcs.	
<b>E0826</b>  E0826 4pcs.	<b>E0827</b>  E0827 2pcs.
<b>E0828</b>  E0828 1pc.  E0828A 3pcs.  E0828B 2pcs.  E0828C 3pcs.  E0828D 3pcs.  E0828E 1pc.  E0828F 2pcs.  E0828G 2pcs.	
<b>E0829</b>  E0829 4pcs.	<b>E0830</b> OPT  E0830 2pcs.
<b>E0831</b> OPT  E0831 4pcs.  E0831A 4pcs.  E0831B 2pcs.  E0831C 2pcs.  E0831D 2pcs.  E0831E 2pcs.	
<b>E0832</b> OPT  E0832 2pcs.  E0832A 2pcs.  E0832B 2pcs.  E0832C 2pcs.  E0832D 2pcs.  E0832E 2pcs.  E0832F 2pcs.	

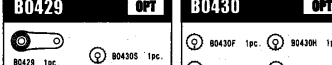
- E0803 FUEL TANK BUSH
- D0806 ANTENNA PIPE
- E0806 TURN BUCKLE ROD 35mm
- D0807 BODY PIN 15/21
- E0808 TITANIUM TURN BUCKLE ROD 35mm
- E0811-B REAR UPPER ARM LINK (LONG)
- E0814 BALL LINK φ 7mm
- E0824 FUEL TANK
- E0825 FUEL GUARD
- E0826 STEERING PIVOT BALL
- E0827 STEERING ROD 44
- E0828 LINKAGE SET
- E0829 ANTI-ROLL LINK BALL
- E0830 TITANIUM STEERING ROD 44
- E0831 TITANIUM SCREW SET A
- E0832 TITANIUM SCREW SET B

<b>H0855</b>  H0855 10pcs.	<b>H0867</b>  H0867 4pcs. (Silver)
<b>E0901</b>  E0901 1pc. SK4x5 1pc.	<b>E1010</b>  E1010 1pc. WHITE
<b>E1010</b>  E1010 1pc. YELLOW	<b>E1011</b> OPT  E1011 1pc. BLACK
<b>E1012</b> OPT  E1012 1pc. WHITE	<b>E1013</b>  E1013 1pc. YELLOW
<b>E1014</b> OPT  E1014 4pcs. WHITE	<b>E1015</b> OPT  E1015 4pcs. YELLOW
<b>P0218</b> OPT  P0218 1pc.	<b>P0401</b> OPT  P0401 1pc.
<b>B0429</b> OPT  B0429 1pc.	<b>B0430</b> OPT  B0430 1pc.
<b>H0855</b> BALL LINK φ 6mm (C0111C)	<b>H0867</b> PIVOT BALL
<b>E0901</b> MUFFLER STAY	<b>E1010</b> WING WHITE
<b>E1010</b> WING YELLOW	<b>E1011</b> WING BLACK
<b>E1012</b> BODY	<b>E1013</b> WHEEL WHITE (4pcs.)
<b>E1014</b> WHEEL YELLOW (4pcs.)	<b>E1015</b> WHEEL YELLOW (4pcs.)
<b>P0218</b> STICKER FLAGE & FLAME	<b>P0401</b> 08 LOGO STICKER
<b>B0429</b> AL SERVO HORN SET	<b>B0430</b> SERVO HORN PARTS

OTHER OPTIONAL PARTS

- B0103 FUEL FILTER L
- B0115 FUEL PUMP 500ml
- B0203 QUICK BOOSTER
- B0207 POCKET BOOSTER
- B0208 DC ADAPTOR FOR POCKET BOOSTER
- B0209 BOOSTER CHARGER FOR AC 100V
- B0230 PRO STARTER BI
- B0233 BATTERY CODE FOR RI/BI
- B0242 POWER PACK 1500 W/FUTABA (6V)
- B0243 POWER PACK 1500 W/SANWA-Z (6V)
- B0301 LOCKFIRM LIQUID
- B0303 ENGINE MAINTENANCE OIL
- B0310 SUPER SILICONE #100
- B0311 SUPER SILICONE #150
- B0312 SUPER SILICONE #200
- B0313 SUPER SILICONE #250
- B0314 SUPER SILICONE #300
- B0315 SUPER SILICONE #350
- B0316 SUPER SILICONE #400
- B0317 SILICONE FOR DIFF. #10000
- B0318 SILICONE FOR DIFF. #30000
- B0319 SILICONE FOR DIFF. #50000
- B0320 SILICONE FOR DIFF. #100000
- B0321 SILICONE FOR DIFF. #3000
- B0322 SILICONE FOR DIFF. #5000
- B0323 SILICONE FOR DIFF. #7000
- B0324 SILICONE FOR DIFF. #1000
- B0325 SUPER SILICONE #500
- B0326 SUPER SILICONE #600
- B0327 SUPER SILICONE #700
- B0328 SUPER SILICONE #800
- B0329 AIR FILTER OIL
- B0330 SUPER JOINT GREASE
- B0332 SUPER SILICONE #450
- B0333 SUPER SILICONE #550
- B0334 SILICONE FOR DIFF. #2000
- B0335 SILICONE FOR DIFF. #4000
- B0401 SWITCH COVER
- B0406 BOTH SIDED ADHESIVE TAPE
- B0407 FLAT WASHER 3mm
- B0408 FLAT WASHER 4mm
- B0410 COLOR SILICONE PIPE PINK
- B0411 COLOR SILICONE PIPE GREEN
- B0412 COLOR SILICONE PIPE YELLOW
- B0413 COLOR SILICONE PIPE GRAY
- B0422 BODY PIN
- B0424 PORT CAP (L+M)
- B0428 VELCRO TAPE
- B0508 UTILITY WRENCH
- B0509 SETTING DRIVER FOR ENGINE
- B0510 CAMBER GAUGE
- B0512 CROSS WRENCH
- B0522 (-) 0.5 SCREW DRIVER
- B0523 1.5mm Hex. WRENCH
- B0524 2.0mm Hex. WRENCH
- B0525 2.5mm Hex. WRENCH
- B0526 3.0mm Hex. WRENCH
- B0527 2.0mm Ball-Hex. WRENCH
- B0528 2.5mm Ball-Hex. WRENCH
- B0529 PRO SPEC TOOLS SET
- B0522/1 SPARE TIP FOR (-) 0.5 SCREW DRIVER
- B0523/1 SPARE TIP FOR 1.5mm Hex. WRENCH
- B0524/1 SPARE TIP FOR 2.0mm Hex. WRENCH
- B0525/1 SPARE TIP FOR 2.5mm Hex. WRENCH
- B0526/1 SPARE TIP FOR 3.0mm Hex. WRENCH
- B0527/1 SPARE TIP FOR 2.0mm Ball-Hex. WRENCH
- B0528/1 SPARE TIP FOR 2.5mm Ball-Hex. WRENCH
- B0530 2.0mm HEX. WRENCH TIP FOR ELECTRIC DRIVER
- B0531 2.5mm HEX. WRENCH TIP FOR ELECTRIC DRIVER
- B0533 CURVED SCISSORS
- B0534 HEIGHT GAUGE R
- B0535 BOX WRENCH 5.5mm
- B0536 BOX WRENCH 7.0mm
- B0537 BOX WRENCH 5.0mm
- B0538 PRO SPEC Hex. WRENCH SET

- B0663 SG3X12 CAP SCREW
- B0667 SG2X12 CAP SCREW
- B0668 SG2X5 CAP SCREW
- B0669 SG2.8X8 CAP SCREW
- B06601 SG3X25 CAP SCREW
- B0670 SK3X3 SET SCREW
- B0671 SK3X5 SET SCREW
- B0680 SK4X4 SET SCREW
- B0682 SK4X8 SET SCREW
- B0690 SK5X5 SET SCREW
- B0712 SN2.6 NYLON NUT
- B0713 SN3 NYLON NUT
- B0714 SN4 NYLON NUT
- B0723 OW 3X8X0.5 WASHER
- B0725 OW 2.5X8X0.5 WASHER
- B0726 OW 5X8X0.1 WASHER
- B0730 SIG3X8 B/H SCREW
- B0731 SIG3X10 B/H SCREW
- B0732 SIG3X12 B/H SCREW
- B0734 SIG3X16 B/H SCREW
- B0735 SIG3X18 B/H SCREW
- B0736 SIG3X6 B/H SCREW
- B0737 SIG3X23 B/H SCREW
- B07302 SIG3X28 B/H SCREW
- B0737 SIG3X20 B/H SCREW
- B0740 SJG3X8 F/H CAP SCREW
- B0741 SJG3X10 F/H CAP SCREW
- B0742 SJG3X6 F/H CAP SCREW
- B0743 SJG3X12 F/H CAP SCREW
- B0746 SJG4X8 F/H CAP SCREW
- B0747 SJG4X10 F/H CAP SCREW
- B0748 SJG4X15 F/H CAP SCREW
- B0751 SJG3X32 F/H CAP SCREW
- B0730T SIG3X8 B/H TITANIUM SCREW
- B0731T SIG3X10 B/H TITANIUM SCREW
- B0732T SIG3X12 B/H TITANIUM SCREW
- B0734T SIG3X16 B/H TITANIUM SCREW
- B0735T SIG3X18 B/H TITANIUM SCREW
- B0736T SIG3X6 B/H TITANIUM SCREW
- B07301T SIG3X23 B/H TITANIUM SCREW
- B07302T SIG3X28 B/H TITANIUM SCREW
- B0737T SIG3X20 B/H TITANIUM SCREW
- B0740T SJG3X8 F/H TITANIUM SCREW
- B0741T SJG3X10 F/H TITANIUM SCREW
- B0742T SJG3X6 F/H TITANIUM SCREW
- B0743T SJG3X12 F/H TITANIUM SCREW
- B0746T SJG4X8 F/H TITANIUM SCREW
- B0747T SJG4X10 F/H TITANIUM SCREW
- B0748T SJG4X15 F/H TITANIUM SCREW
- B0751T SJG3X32 F/H TITANIUM SCREW

**MUGEN SEIKI**

株式会社 無限精機 〒274-0817 千葉県船橋市高根町1-395

**MUGEN SEIKI CO., LTD.**

1395 Takane-cho, Funabashi, Chiba 274-0817, Japan

表示画像には消費税が含まれていません。